



**ROHDE & SCHWARZ**

Test and Measurement  
Division

## **Operating Manual**

# **3GPP FDD Base Station Test 3GPP FDD-HSDPA Base Station Test**

## **Application Firmware Module R&S FS-K72/K74**

**1154.7000.02**

**1300.7156.02**

Printed in the Federal  
Republic of Germany

Throughout this manual, FS-K72/K74 is generally used as an abbreviation for the software option R&S FS-K72/K74. The Spectrum Analyzer R&S FSU is abbreviated as FSU, the Vector Signal Generator R&S SMIQ as SMIQ.

# Contents

Safety Instructions  
 Certificate of Quality  
 Support Center Address  
 List of R&S Representatives

## Contents of Application Firmware FS-K72/K74 Manual

<b>3GPP FDD Base Station Test - Application Firmware FS-K72/K74 .....</b>	<b>9</b>
<b>1 Enabling the Firmware Option .....</b>	<b>9</b>
<b>2 Getting Started.....</b>	<b>10</b>
Basic Settings in Code Domain Measurement Mode.....	11
Measurement 1: Measurement of the Signal Channel Power.....	11
Measurement 2: Measurement of the Spectrum Emission Mask .....	12
Measurement 3: Measurement of the Relative Code Domain Power.....	13
Setting: Synchronization of the Reference Frequencies .....	13
Setting: Behaviour with Deviating Center Frequency Setting .....	14
Setting: Behaviour with Incorrect Scrambling Code .....	14
Measurement 4: Triggered Measurement of Relative Code Domain Power .....	15
Setting: Trigger Offset .....	15
Measurement 5: Measurement of the Composite EVM .....	16
Measurement 6: Measurement of Peak Code Domain Error .....	17
Measurement 7: Measurement of the Trigger To Frame Time .....	18
Resolution of the TTF time measurement.....	18
Absolute accuracy of theTTF time measurement .....	19
Trace statistic in the result summary display .....	20
<b>3 Setup for Base Station Tests .....</b>	<b>22</b>
Standard Test Setup.....	22
Presetting.....	23
<b>4 3GPP FDD Test Models.....</b>	<b>24</b>
<b>5 Menu Overview .....</b>	<b>26</b>
<b>6 Configuration of 3GPP FDD Measurements .....</b>	<b>28</b>
Measurement of Channel Power .....	29
Measurement of Adjacent-Channel Power - ACLR.....	30
Measurement of Multi Carrier Adjacent-Channel Power – MULT CARR ACLR .....	37
Signal Power Check – SPECTRUM EM MASK .....	44
Measurement of Occupied Bandwidth - OCCUPIED BANDWIDTH .....	49
Signal Statistics .....	51
Code Domain Measurements on 3GPP FDD Signals.....	55
Display Mode – <i>RESULTS</i> hotkey .....	57
Measurement Configuration – <i>CHAN CONF</i> hotkey.....	78
Configuration of CDP Measurement – <i>SETTINGS</i> hotkey .....	83
Frequency Settings – <i>FREQ</i> key.....	91
Span Settings – <i>SPAN</i> key .....	91
Level Settings – <i>AMPT</i> key .....	92
Marker Settings – <i>MKR</i> key .....	93
Changing Instrument Settings – <i>MKR</i> → key.....	94
Marker Functions – <i>MKR FCTN</i> key .....	95

	Bandwidth Setting – <i>BW</i> key.....	95
	Measurement Control – <i>SWEEP</i> key.....	95
	Measurement Selection – <i>MEAS</i> key.....	95
	Trigger Settings – <i>TRIG</i> key.....	95
	Trace Settings – <i>TRACE</i> key.....	96
	Display Lines – <i>LINES</i> key.....	98
	Settings of Measurement Screen – <i>DISP</i> key.....	98
	Storing and Loading of Unit Data – <i>FILE</i> key.....	98
<b>7</b>	<b>Remote Control Commands.....</b>	<b>99</b>
	CALCulate:FEED - Subsystem.....	99
	CALCulate:LIMit – Subsystem.....	101
	CALCulate:LIMit:ACPower Subsystem.....	101
	CALCulate:LIMit:SPECtrum Subsystem.....	106
	CALCulate:MARKer – Subsystem.....	107
	CALCulate:PEAKsearch – Subsystem.....	110
	CALCulate:STATistics – Subsystem.....	111
	CONFigure:WCDPower – Subsystem.....	113
	DISPlay – Subsystem.....	117
	FORMat – Subsystem.....	118
	INSTRument – Subsystem.....	119
	MMEMory – Subsystem.....	120
	SENSE:CDPower – Subsystem.....	121
	SENSE:Power – Subsystem.....	125
	SENSE:SWEEp – Subsystem.....	130
	STATus-QUESTionable:SYNC Register.....	131
	TRACe – Subsystem.....	132
	Table of Softkeys with Assignment of IEC/IEEE Commands.....	139
<b>8</b>	<b>Performance Test.....</b>	<b>147</b>
	Required Measuring Equipment and Accessories.....	147
	Test Procedure.....	147
<b>9</b>	<b>Glossary.....</b>	<b>150</b>
<b>10</b>	<b>Index.....</b>	<b>151</b>

## Figures

Fig. 3-1	BTS test setup .....	22
Fig. 5-1	Overview of menus - code domain power .....	26
Fig. 5-2	Overview of menus - measurements.....	27
Fig. 6-1	Power measurement in the 3.84 MHz transmission channel.....	29
Fig. 6-2	Adjacent-channel power measurement of a 3GPP FDD base station .....	30
Fig. 6-3	Measurement of spectrum emission mask.....	44
Fig. 6-4	Peak list of spectrum emission mask .....	47
Fig. 6-5	Measurement of occupied bandwidth.....	49
Fig. 6-6	CCDF of a 3GPP FDD signal .....	51
Fig. 6-7	Indication of measurement parameters.....	58
Fig. 6-8	CDP diagram with all channels recognized as active .....	60
Fig. 6-9	CDP diagram with one of the channels recognized as inactive .....	60
Fig. 6-10	CDP diagram with some channels including an incorrect pilot sequence. ....	61
Fig. 6-11	CDP diagram for test model 5.....	61
Fig. 6-12	Composite EVM - all channels are recognized as active .....	62
Fig. 6-13	Composite EVM - one channel is recognized as inactive.....	62
Fig. 6-14	Peak domain error - all channels are recognized as active .....	63
Fig. 6-15	Peak domain error - one channel is not recognized as active.....	63
Fig. 6-16	Power versus slot for a channel with power control (timing offset 22528 chips) .....	64
Fig. 6-17	Power versus slot for a channel with incorrect pilot symbols at channel slots 10 and 13. ....	65
Fig. 6-18	Result summary .....	66
Fig. 6-19	Composite constellation diagram.....	68
Fig. 6-20	Code domain error display of a correct WCDMA signal .....	69
Fig. 6-21	Code domain error display of an incorrect WCDMA signal .....	69
Fig. 6-22	Channel table of FS-K72 and measuring test model 1.....	71
Fig. 6-23	Channel table including HSDPA channels of FS-K74 and measuring test model 5.....	72
Fig. 6-24	Power versus symbol for one slot of a channel with 20 symbols .....	73
Fig. 6-25	Symbol constellation diagram .....	74
Fig. 6-26	Symbol constellation diagram for 16QAM .....	74
Fig. 6-27	Error vector magnitude for the selected slot of the selected channel.....	75
Fig. 6-28	Demodulated bits for the selected slot of the selected channel .....	75
Fig. 6-29	Demodulated bits with pilot symbols.....	76
Fig. 6-30	Demodulated bits for the selected slot of the selected channel in the case of 16QAM.....	76
Fig. 6-31	Table for editing a channel configuration .....	79
Fig. 6-32	Creating a new channel configuration .....	82
Fig. 6-33	Channel table of a signal with compressed channels.....	86
Fig. 6-34	Code domain power and power versus slot of a compressed channel .....	87
Fig. 6-35	Data scheme of the captured and analyzed frames .....	88
Fig. 6-36	Parameters of marker info field.....	93
Fig. 6-37	Result summary with applied average mode.....	97

**Tables**

Table 2-1: Default settings for code domain measurement..... 11

Table 4-1: Test model 1 ..... 24

Table 4-2: Test model 2 ..... 24

Table 4-3: Test model 3 ..... 24

Table 4-4: Test model 4 ..... 25

Table 4-5: Test model 5 ..... 25

Table 6-1: Maximum compensated frequency error ..... 66

Table 6-2: Maximum number of captured frames ..... 89

Table 7-1: Definition of the error bits of the SYNC register..... 131

Table 8-1 Required measuring equipment and accessories..... 147

## Contents of Operating Manual for Application Firmware FS-K72/K74

This manual contains all information about the operation of an FSU equipped with Application Firmware FS-K72/K74. It covers operation via menus and the remote control commands for the 3GPP FDD base station test.

This manual consists of the data sheet and 10 chapters:

<b>Data sheet</b>	Lists the guaranteed specifications and the firmware characteristics.
<b>Chapter 1</b>	Describes the procedure for enabling the application firmware module.
<b>Chapter 2</b>	Provides typical examples of measurements by means of tests.
<b>Chapter 3</b>	Describes the measurement setup for base station tests.
<b>Chapter 4</b>	Describes the 3GPP FDD test models as stipulated in the BTS test (3G TS 25.141 V3.7.0).
<b>Chapter 5</b>	Provides a schematic overview of the FS-K72/K74 control menus.
<b>Chapter 6</b>	Contains a detailed description of the possible base station test measurements as a reference for manual operation. This chapter also presents a list of remote control commands associated with each function.
<b>Chapter 7</b>	Describes all remote control commands defined for the code domain measurement. An alphabetic list of all remote control commands and a table of softkeys with the assignment of commands are provided at the end of this chapter.
<b>Chapter 8</b>	Contains the performance test.
<b>Chapter 9</b>	Contains an explanation of terms related to measured quantities of the code domain measurement.
<b>Chapter 10</b>	Contains the index for this operating manual.

This manual is a supplement to the FSU operating manual. It exclusively includes functions of Application Firmware FS-K72/K74. For all other descriptions, please refer to the FSU operating manual.





# 3GPP FDD Base Station Test - Application Firmware FS-K72/K74

The Spectrum Analyzer FSU equipped with Application Firmware FS-K72 performs code domain power measurements on downlink signals according to the 3GPP standard (FDD mode). The application firmware is in line with the 3GPP standard (Third Generation Partnership Project) with Release 5. Signals that meet the conditions for channel configuration of test models 1 to 4 according to the 3GPP standard can be measured with FS-K72. In addition to the code domain measurements specified by the 3GPP standard, the application firmware offers measurements with predefined settings in the frequency domain, e.g. power and ACLR measurements. The FSU equipped with Application Firmware FS-K74 additionally allows measurements to be performed on test model 5 (HSDPA). FS-K72 must be installed before FS-K74 is installed on the FSU.

## 1 Enabling the Firmware Option

Firmware option FS-K72/K74 is enabled in the *GENERAL SETUP* menu by entering a keyword. The keyword is delivered together with the option. FS-K72 and FS-K74 have different keywords. FS-72 must be installed before FS-K74 is installed. If the options are factory-installed, they are already enabled.

*GENERAL SETUP* menu:

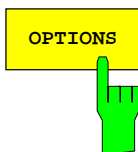

The *OPTIONS* softkey opens a submenu where keywords for new firmware options (application firmware modules) can be entered. Available options are displayed in a table, which is opened during submenu entry.

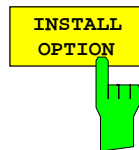

The *INSTALL OPTION* softkey activates the keyword entry for a firmware option.

One or more keywords can be entered in the entry field. When a valid keyword is entered, *OPTION KEY OK* is displayed in the message line and the option is entered in the *FIRMWARE OPTIONS* table.

In case of invalid keywords, *OPTION KEY INVALID* is displayed on the message line.

## 2 Getting Started

This chapter explains basic 3GPP FDD base station tests by means of a setup with a Signal Generator R&S SMIQ. It describes how operating and measurement errors can be avoided using correct presetting. The measurements are performed with an analyzer equipped with FS-K72. Additionally Installing FS-K74 is not required.

The measurement screen is presented in chapter 6 for each measurement.

Key settings are shown as examples to avoid measurement errors. Following the correct setting, the effect of an incorrect setting is shown. The following measurements are performed:

- Measurement 1: Measurement of the spectrum
- Measurement 2: Measurement of the spectrum emission mask
- Measurement 3: Measurement of the relative code domain power
  - Setting: Analyzer center frequency set to the DUT frequency
  - Setting: Scrambling code of signal
- Measurement 4: Triggered measurement of the relative code domain power
  - Setting: Trigger offset
- Measurement 5: Measurement of the composite EVM
- Measurement 6: Measurement of the peak code domain error

The measurements are performed using the following units and accessories:

- The Spectrum Analyzer FSU with Application Firmware FS-K72: 3GPP FDD base station test
- The Vector Signal Generator SMIQ with option SMIQB45: digital standard 3GPP (options SMIQB20 and SMIQB11 required)
- 1 coaxial cable, 50  $\Omega$ , approx. 1 m, N connector
- 1 coaxial cable, 50  $\Omega$ , approx. 1 m, BNC connector

- Conventions for displaying settings on the FSU:

[<KEY>]                    Press a key on the front panel, e.g. **[SPAN]**.  
 [<SOFTKEY>]                Press a softkey, e.g. **[MARKER -> PEAK]**.  
 [<nn unit>]                Enter a value and terminate by entering the unit, e.g. **[12 kHz]**.

- Conventions for displaying settings on the SMIQ:

[<KEY>]                    Press a key on the front panel, e.g. **[FREQ]**.  
 <MENU>                    Select a menu, parameter or a setting, e.g. **DIGITAL STD**.  
                                   The menu level is marked by an indentation.  
 <nn unit>                Enter a value and terminate by entering the unit, e.g. **12 kHz**.

## Basic Settings in Code Domain Measurement Mode

In the default mode after a PRESET, the FSU is in the analyzer mode. The following default settings of the code domain measurement are activated provided that the code domain measurement mode is selected.

Table 2-1: Default settings for code domain measurement

Parameter	Setting
Digital standard	W-CDMA 3GPP FWD
Sweep	CONTINUOUS
CDP mode	CODE CHAN AUTOSEARCH
Trigger settings	FREE RUN
Trigger offset	0
Scrambling code	0
Threshold value	-60 dB
Symbol rate	15 ksps
Code number	0
Slot number	0
Display	Screen A: CODE PWR RELATIVE Screen B: RESULT SUMMARY

### Measurement 1: Measurement of the Signal Channel Power

The FSU measures the unweighted RF signal power in a bandwidth of:

$$f_{BW} = 5 \text{ MHz} \geq (1 + \alpha) \cdot 3.84 \text{ MHz} \quad | \quad \alpha = 0.22$$

The power is measured in the zero span mode (time domain measurement) using a digital channel filter of 5 MHz in bandwidth. According to the 3GPP standard, the measurement bandwidth is 5 MHz.

Test setup ➤ Connect the RF output of the SMIQ to the RF input of the FSU (coaxial cable with N connectors).

Settings on the SMIQ:

```
[PRESET]
[LEVEL:           0 dBm]
[FREQ:           2.1175 GHz]
DIGITAL STD
  WCDMA/3GPP
    TEST MODELS ...
      TEST1_32
    STATE: ON
```

Settings on the FSU:

```
[PRESET]
[CENTER:         2.1175 GHz]
[AMPT:           0 dBm]
[3G FDD BS]
[MEAS:           POWER]
```

Measurement on the FSU: The following is displayed:

- Time domain trace of the WCDMA signal.
- Signal channel power within a bandwidth of 5 MHz (in the marker info field)

## Measurement 2: Measurement of the Spectrum Emission Mask

The 3GPP specification defines a measurement that monitors compliance with a spectral mask in a range of at least  $\pm 12.5$  MHz around the WCDMA carrier. To assess the power emissions in the specified range, the signal power is measured in the range near the carrier by means of a 30 kHz filter, and in the ranges far away from the carrier by means of a 1 MHz filter. The resulting trace is compared to a limit line defined in the 3GPP specification.

Test setup ➤ Connect the RF output of the SMIQ to the RF input of the FSU (coaxial cable with N connectors).

Settings on the SMIQ:

```

[PRESET]
[LEVEL:                0 dBm]
[FREQ:                2.1175 GHz]
DIGITAL STD
  WCDMA/3GPP
    TEST MODELS ...
      TEST1_32
        STATE: ON
  
```

Settings on the FSU:

```

[PRESET]
[CENTER:             2.1175 GHz]
[AMPT:               0 dBm]
[3G FDD BS]
[MEAS:               SPECTRUM EM MASK]
  
```

Measurement on the FSU:

The following items are displayed:

- Spectrum of the 3GPP FDD signal
- Limit line defined in the standard
- Information on limit line violations (passed/failed)

### Measurement 3: Measurement of the Relative Code Domain Power

A code domain power measurement on one of the test models (model 1 with 32 channels) is shown in the following. To demonstrate the effects, the basic parameters of the CDP measurements permitting an analysis of the signal are changed one after the other from values adapted to the measurement signal to non-adapted values.

Test setup

- Connect the RF output of the SMIQ to the input of the FSU.
- Connect the reference input (EXT REF IN/OUT) on the rear panel of the analyzer to the reference input (REF) on the rear panel of the SMIQ (coaxial cable with BNC connectors).

Settings on the SMIQ:

```
[PRESET]
[LEVEL:           0 dBm]
[FREQ:           2.1175 GHz]
DIGITAL STD
  WCDMA 3GPP
    TEST MODELS ...
      TEST1_32
    STATE: ON
```

Settings on the FSU:

```
[PRESET]
[CENTER:         2.1175 GHz]
[AMPT:           10 dBm]
[3G FDD BS]
[SETTINGS:   SCRAMBLING CODE 0]
```

Measurement on the FSU:

The following is displayed:

Screen A: Code domain power of signal  
(test model 1 with 32 channels)

Screen B: Numeric results of CDP measurement

### Setting: Synchronization of the Reference Frequencies

Synchronization of the reference oscillators both of the DUT and the analyzer strongly reduces the measured frequency error.

Test setup

- Connect the reference input (EXT REF IN/OUT) on the rear panel of the analyzer to the reference output (REF) on the rear panel of the SMIQ (coaxial cable with BNC connectors).

Settings on the SMIQ: *Same as for measurement 2*

Settings on the FSU: *Same as for measurement 2 plus*

```
[SETUP:           REFERENCE EXT]
```

Measurement on the FSU: Frequency error The displayed frequency error should be <10 Hz.

**The reference frequencies of the analyzer and of the DUT should be synchronized.**

## Setting: Behaviour with Deviating Center Frequency Setting

In the following, the behaviour of the DUT and the analyzer with an incorrect center frequency setting is shown.

Settings on the SMIQ: ➤ Tune the center frequency of the signal generator in 0.5 kHz steps and watch the analyzer screen:

Measurement on the FSU:

- A CDP measurement on the analyzer is still possible with a frequency error of up to approx. 1 kHz. Up to 1 kHz, a frequency error causes no apparent difference in the accuracy of the code domain power measurement.
- Above a frequency error of 1 kHz, the probability of impaired synchronization increases. With continuous measurements, all channels are at times displayed in blue with almost the same level.
- Above a frequency error of approx. 2 kHz, a CDP measurement cannot be performed. The FSU displays all possible codes in blue with a similar level.

Settings on the SMIQ: ➤ Set the signal generator center frequency to 2.1175 GHz again:  
**[FREQ: 2.1175 GHz]**

**The analyzer center frequency should not differ from the DUT frequency by more than 2 kHz.**

## Setting: Behaviour with Incorrect Scrambling Code

A valid CDP measurement can be carried out only if the scrambling code set on the analyzer is identical to that of the transmitted signal.

Test setup

```

SELECT BS/MS
BS 1: ON
SCRAMBLING CODE: 0001
(the scrambling code is set to 0000 on the analyzer)

```

Settings on the SMIQ: The CDP display shows all possible codes with approximately the same level.

Settings on the FSU: Set scrambling code to new value:  
**[SETTINGS: SCRAMBLING CODE 1]**

Measurement on the FSU: The CDP display again shows the test model.

**The scrambling code setting of the analyzer must be identical to that of the measured signal.**



## Measurement 5: Measurement of the Composite EVM

The 3GPP specification defines the composite EVM measurement as the average square deviation of the total signal:

An ideal reference signal is generated from the demodulated data. The test signal and the reference signal are compared with each other. The square deviation yields the composite EVM.

- Test setup
- Connect the RF output of the SMIQ to the input of the FSU.
  - Connect the reference input (EXT REF IN/OUT) on the rear panel of the FSU to the reference input (REF) on the rear panel of the SMIQ (coaxial cable with BNC connectors).
  - Connect the external trigger input on the rear panel of the FSU (EXT TRIG GATE) to the external trigger output on the rear panel of the SMIQ (TRIGOUT1 of PAR DATA).

Settings on the SMIQ:

```

[PRESET]
[LEVEL:                0 dBm]
[FREQ:                2.1175 GHz]
DIGITAL STD
  WCDMA 3GPP
    TEST MODELS ...
      TEST4
    SELECT BS/MS
      BS 1 ON
        CPICH STATE ON
          STATE: ON
  
```

Settings on the FSU:

```

[PRESET]
[CENTER:            2.1175 GHz]
[REF:                10 dBm]
[3G FDD BS]
[TRIG                EXTERN]
[RESULTS            COMPOSITE EVM]
  
```

Measurement on the FSU:

The following is displayed:

Screen A: Code domain power of signal  
(Test model 4)

Screen B: Composite EVM (EVM for total signal)



## Measurement 6: Measurement of Peak Code Domain Error

The peak code domain error measurement is defined in the 3GPP specification for WCDMA signals. An ideal reference signal is generated from the demodulated data. The test signal and the reference signal are compared with each other. The difference of the two signals is projected onto the classes of the different spreading factors. The peak code domain error measurement is obtained by summing the symbols of each difference signal slot and searching for the maximum error code.

- Test setup
- Connect the RF output of the SMIQ to the input of the FSU.
  - Connect the reference input (EXT REF IN/OUT) on the rear panel of the FSU to the reference input (REF) on the rear panel of the SMIQ (coaxial cable with BNC connectors).
  - Connect the external trigger input on the rear panel of the FSU (EXT TRIG GATE) to the external trigger output on the rear panel of the SMIQ (TRIGOUT1 of PAR DATA).

Settings on the SMIQ:

```

[PRESET]
[LEVEL:                0 dBm]
[FREQ:                2.1175 GHz]
DIGITAL STD
  WCDMA 3GPP
    TEST MODELS ...
      TEST1_32
    STATE: ON
  
```

Settings on the FSU:

```

[PRESET]
[CENTER:            2.1175 GHz]
[REF:              0 dBm]
[3G FDD BS]
[TRIG              EXTERN]
[RESULTS          PEAK CODE DOMAIN ERR]
                   SELECT PCDE SF 256
  
```

Measurement on the FSU:

The following items are displayed:

Screen A: Code domain power of signal  
(test model 1 with 32 channels)

Screen B: Peak code domain error (projection of error onto the class  
with spreading factor 256)

## Measurement 7: Measurement of the Trigger To Frame Time

The trigger to frame (TTF) time measurement yields the time between an external trigger event and the start of the 3GPP WCDMA frame. The result is displayed in the result summary. The trigger event is expected in a time range of one slot (667us) before the frame start. The resolution and absolute accuracy depend on the analyzer type and the measurement mode.

### Resolution of the TTF time measurement

The resolution of the TTF time depends on the analyzer type that is used and the applied trace statistic mode. By using an average mode, the resolution can be increased. The higher the number of sweeps, the higher the resolution at the expense of measurement time. In the average mode, the TTF time is averaged for a number of sweeps (TRACE→SWEEP COUNT). If the TTF time of the applied signal does not change during for this number of sweeps, the trigger resolution can be improved.

TTF time resolution in dependency of the analyzer type and the statistic mode:

Analyzer	Trace mode	TTF resolution	Number of sweeps
R&S - FSQ	CLEAR/WRITE	< 8 ns	1
R&S - FSQ	AVERAGE	< 0.5 ns	100
R&S - FSU	CLEAR/WRITE	< 65 ns	1
R&S - FSU	AVERAGE	< 4 ns	100
R&S - FSP	CLEAR/WRITE	< 65 ns	1
R&S - FSP	AVERAGE	< 4 ns	100

### Absolute accuracy of the TTF time measurement

The absolute accuracy of the TTF time measurement depends on the level of the trigger pulse. The analyzer is calibrated to display the minimum deviation at a trigger pulse level of 4 V. The trigger threshold for an external trigger event is 1.4 V. Due to an internal lowpass between the back panel and the trigger detector, the trigger pulse is delayed in correlation to its own level.

The absolute error of the TTF time measurement as a function of the trigger level is as follows:

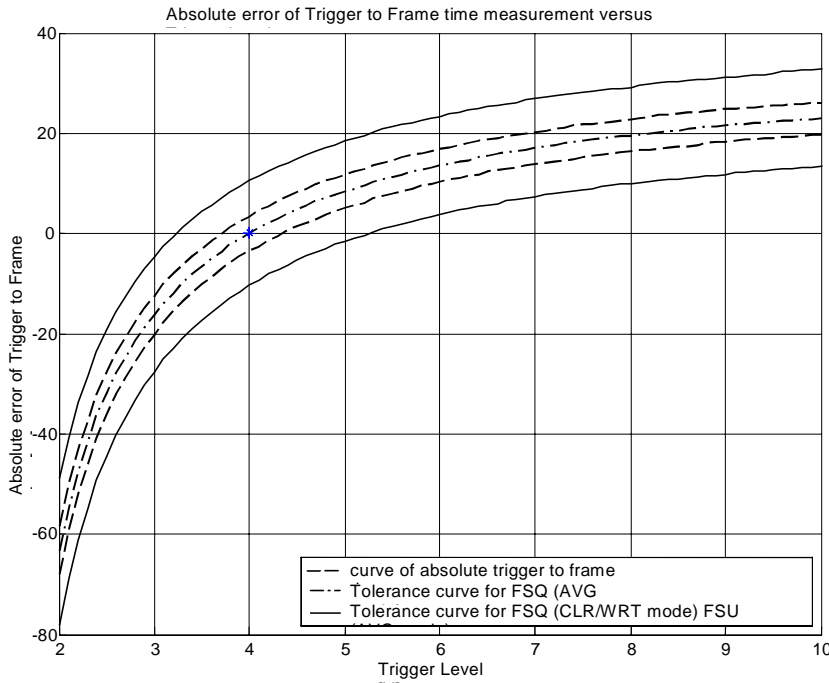

The red curve shows the error of the TTF measurement. The blue and green curves indicate the expected measurement uncertainty as a function of the analyzer type used and the applied trace statistic. To calculate the accurate TTF time, the error needs to be subtracted from the measured TTF value.

$$T_{TrgToFrame} = T_{Meas\_Analyser} - T_{Error}$$

- where:
- $T_{TrgToFrame}$  - correct TTF time
  - $T_{meas\_Analyser}$  - TTF time displayed by the analyzer (K72/K73 result summary)
  - $T_{error}$  - absolute error

## Trace statistic in the result summary display

The trace statistic functions can be enabled by selecting SCREEN B. After screen B is selected, the trace menu can be called (press hardkey TRACE). In the trace menu, the kind of trace statistic can be selected.

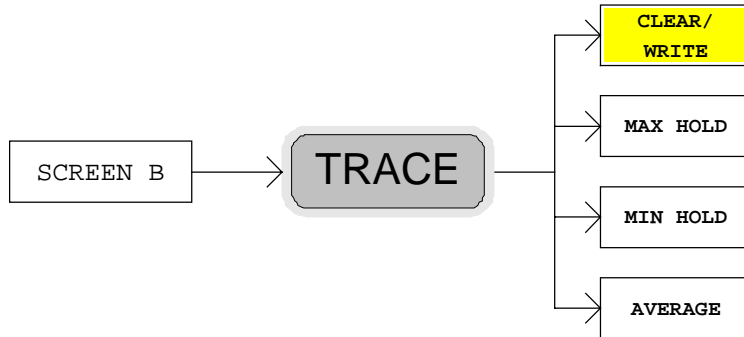

The parameter SWEEP COUNT determines the number of sweeps. The result values in the result summary of screen B are tagged with an abbreviation to indicate which kind of trace statistic is applied to the results. If measured with the trace statistic, the channel table is automatically switched to predefined mode. The last measured channel table is used and stored to "RECENT". In this case, any change in the signal channel configuration does not influence the displayed channel table.

The following trace statistic functions can be applied and are tagged with the corresponding abbreviations shown in the last column:

- CLEAR/WRITE: Displays the result value of the last sweep (<none>)
- MAX HOLD: Displays the maximum result values of a number of sweeps (<MAX>)
- MIN HOLD: Displays the minimum result value of a number of sweeps (<MIN>)
- AVERAGE: Displays the average result value of a number of sweeps (<AVG>)

- Test setup
- Connect the RF output of the SMIQ to the input of the FSU.
  - Connect the reference input (EXT REF IN/OUT) on the rear panel of the FSU to the reference input (REF) on the rear panel of the SMIQ (coaxial cable with BNC connectors).
  - Connect the external trigger input on the rear panel of the FSU (EXT TRIG GATE) to the external trigger output on the rear panel of the SMIQ (TRIGOUT1 of PAR DATA).

Settings on the SMIQ:

```

[PRESET]
[LEVEL:                0 dBm]
[FREQ:                2.1175 GHz]
DIGITAL STD
  WCDMA 3GPP
    TEST MODELS ...
      TEST1_32
    STATE: ON

```

Settings on the FSU:

```

[PRESET]
[CENTER:            2.1175 GHz]
[REF:              0 dBm]
[3G FDD BS]
[TRIG              EXTERN]
[RESULTS          RESULT SUMMARY]
[SCREEN           SCREEN B]
[TRACE:          AVERAGE]
[                CLEAR / WRITE]
[SWEEP COUNT]    <numeric value>

```

Measurement on the FSU:

The following items are displayed:

Screen A: Code domain power of signal  
(test model 1 with 32 channels)

Screen B: Result summary with trace statistic evaluation

### 3 Setup for Base Station Tests



**Caution:**

Before turning the instrument on, the following conditions must be met:

- • Instrument covers are in place and all fasteners are tightened.
- • Fan openings are free from obstructions.
- • Signal levels at the input connectors are all below specified maximum values.
- • Signal outputs are correctly connected and not overloaded.

**Noncompliance with these instructions may cause damage to the instrument.**

This section describes how to set up the analyzer for 3GPP FDD base station tests. As a prerequisite for starting the test, the instrument must be correctly set up and connected to the AC power supply as described in chapter 1 of the operating manual for the analyzer. Furthermore, application firmware module FS-K72 and, in the case of measurements on test model 5, FS-K74 must be properly installed following the instructions provided in chapter 1 of this manual.

#### Standard Test Setup

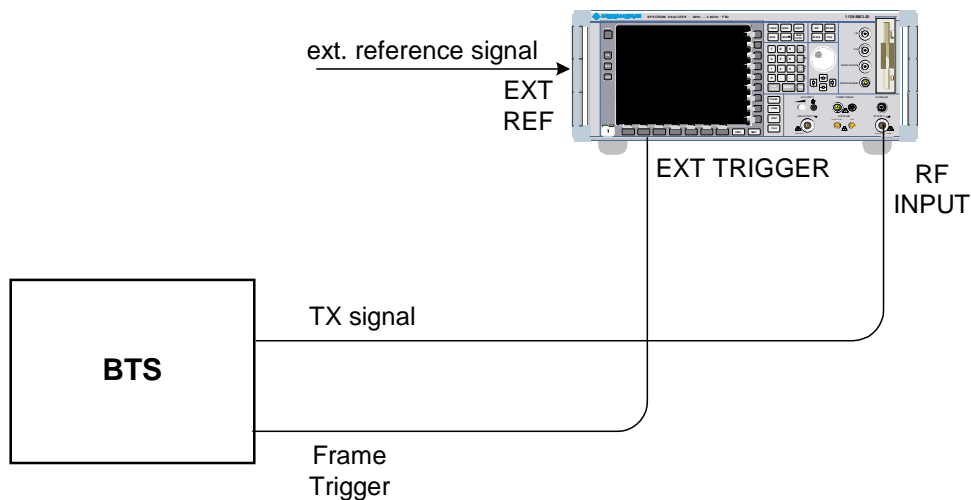

Fig. 3-1 BTS test setup

- Connect antenna output (or TX output) of BTS to RF input of the analyzer via a power attenuator of suitable attenuation.

The following values are recommended for the external attenuator to ensure that the RF input of the analyzer is protected and the sensitivity of the analyzer is not reduced too much.

Max. power	Recommended ext. attenuation
≥55 to 60 dBm	35 to 40 dB
≥50 to 55 dBm	30 to 35 dB
≥45 to 50 dBm	25 to 30 dB
≥40 to 45 dBm	20 to 25 dB
≥35 to 40 dBm	15 to 20 dB
≥30 to 35 dBm	10 to 15 dB
≥25 to 30 dBm	5 to 10 dB
≥20 to 25 dBm	0 to 5 dB
<20 dBm	0 dB

- For signal measurements at the output of two-port networks, connect the reference frequency of the signal source to the rear reference input of the analyzer (*EXT REF IN/OUT*).
- To ensure that the error limits specified by the 3GPP standard are met, the analyzer should use an external reference frequency for frequency measurements on base stations. For instance, a rubidium frequency standard may be used as a reference source.
- If the base station is provided with a trigger output, connect this output to the rear trigger input of the analyzer (*EXT TRIG GATE*).

## Presetting

- Enter external attenuation (REF LVL OFFSET)
- Enter reference level
- Enter center frequency
- Set the trigger
- Select standard and measurement

## 4 3GPP FDD Test Models

For measurements on base-station signals in line with 3GPP, test models with different channel configurations are specified in the document "Base station conformance testing (FDD)" (3GPP TS 25.141 V5.7.0). An overview of the test models is provided in this chapter.

The channel configurations of test models 1 to 3 contain the special channel SCCPCH. With an analyzer equipped with FS-K72, this channel can only be automatically detected in CDP analysis if it contains pilot symbols. For measurements on signals with SCCPCH without pilot symbols, CDP analysis must be performed in the *CODE CHAN PREDEFINED* mode if the analyzer is equipped with FS-K72 only. In this mode, the 3GPP test models 1 to 4 can be used for the measurement at a keystroke (see softkey *CODE CHAN PREDEFINED* for a detailed description). If the analyzer is also equipped with FS-K74, SCCPCH will be detected properly as well in *CODE CHAN AUTOSEARCH* mode.

The channel configuration for test model 5 according to 3GPP contains channels in which the modulation type can vary. These channels can be measured both in *CODE CHAN AUTOSEARCH* and *CODE CHAN PREDEFINED* mode if the analyzer is equipped with FS-K74. In this case, test model 5 can be used as well at a keystroke in mode *CODE CHAN PREDEFINED*.

Test model 1

Table 4-1: Test model 1

Channel type	Number of channels	Power (%)	Level (dB)	Spreading code	Timing offset (x256T <sub>chip</sub> )
PCCPCH+SCH	1	10	-10	1	0
Primary CPICH	1	10	-10	0	0
PICH	1	1.6	-18	16	120
SCCPCH (SF=256)	1	1.6	-18	3	0
DPCH (SF=128)	16/32/64	76.8 total	see TS 25.141	see TS 25.141	see TS 25.141

Table 4-2: Test model 2

Channel type	Number of channels	Power(%)	Level (dB)	Spreading code	Timing offset (x256T <sub>chip</sub> )
PCCPCH+SCH	1	10	-10	1	0
Primary CPICH	1	10	-10	0	0
PICH	1	5	-13	16	120
SCCPCH (SF=256)	1	5	-13	3	0
DPCH (SF=128)	3	2 x 10, 1 x 50	2 x -10, 1 x -3	24, 72, 120	1, 7, 2

Table 4-3: Test model 3

Channel type	Number of channels	Power (%) 16/32	Level (dB) 16/32	Spreading code	Timing offset (x256T <sub>chip</sub> )
PCCPCH+SCH	1	12.6/7.9	-9 / -11	1	0
Primary CPICH	1	12.6/7.9	-9 / -11	0	0
PICH	1	5/1.6	-13 / -18	16	120
SCCPCH (SF=256)	1	5/1.6	-13 / -18	3	0
DPCH (SF=256)	16/32	63,7/80,4 total	see TS 25.141	see TS 25.141	see TS 25.141



Table 4-4: Test model 4

Channel type	Number of channels	Power (%) 16/32	Level (dB) 16/32	Spreading code	Timing offset (x256T <sub>chip</sub> )
PCCPCH+SCH	1	50 to 1.6	-3 to -18	1	0
Primary CPICH*	1	10	-10	0	0

\* The CPICH is optional.

Table 4-5: Test model 5

Channel type	Number of channels	Power (%)	Level (dB)	Spreading code	Timing offset (x256T <sub>chip</sub> )
PCCPCH+SCH	1	7.9	-11	1	0
Primary CPICH	1	7.9	-11	0	0
PICH	1	1.3	-19	16	120
SCCPCH (SF=256)	1	1.3	-19	3	0
DPCH (SF=256)	30/14/6(*)	14/14.2/14.4 total	see TS 25.141	see TS 25.141	see TS 25.141
HS_SCCH	2	4 total	see TS 25.141	see TS 25.141	see TS 25.141
HS_PDSCH (16QAM)	8/4/2(*)	63.6/63.4/63.2 total	see TS 25.141	see TS 25.141	see TS 25.141

\* 2 HS\_PDSCH correspond to 6 DPCH, 4 HS\_PDSCH to 14 DPCH and 8 HS\_PDSCH to 30 DPCH

This test model can be measured with an analyzer equipped with FS-K74.

## 5 Menu Overview

Application Firmware Module FS-K72/K74 (3GPP FDD base station test) extends the analyzer by the code domain measurement mode for the 3GPP FDD standard. Additional softkeys are available that allow overview measurements in the analyzer mode.

The FS-K72/K74 application is started by clicking the 3G FDD BS hotkey:

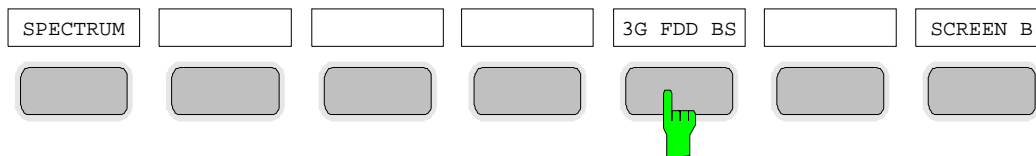

The main settings of the code domain power measurements can be directly selected via the hotkey bar which changes after the application has been started.

When one of the hotkeys *CHAN CONF*, *SETTINGS*, *RESULTS* is selected, measurement is automatically switched to the Code Domain Power measurement mode.

If the *EXIT 3GPP* hotkey is selected, FS-K72/K74 is exited. The hotkey bar of the base unit is displayed again.

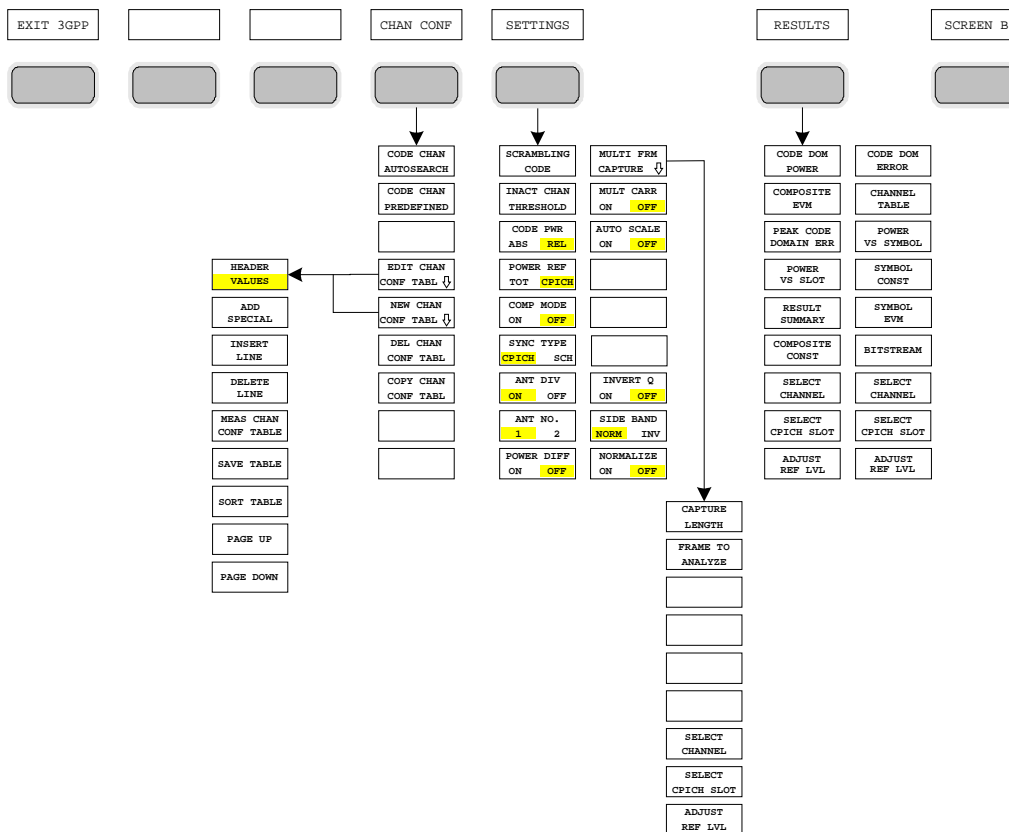

Fig. 5-1 Overview of menus - code domain power

The measurements available in FS-K72/K74 can be selected by means of the MEAS key:

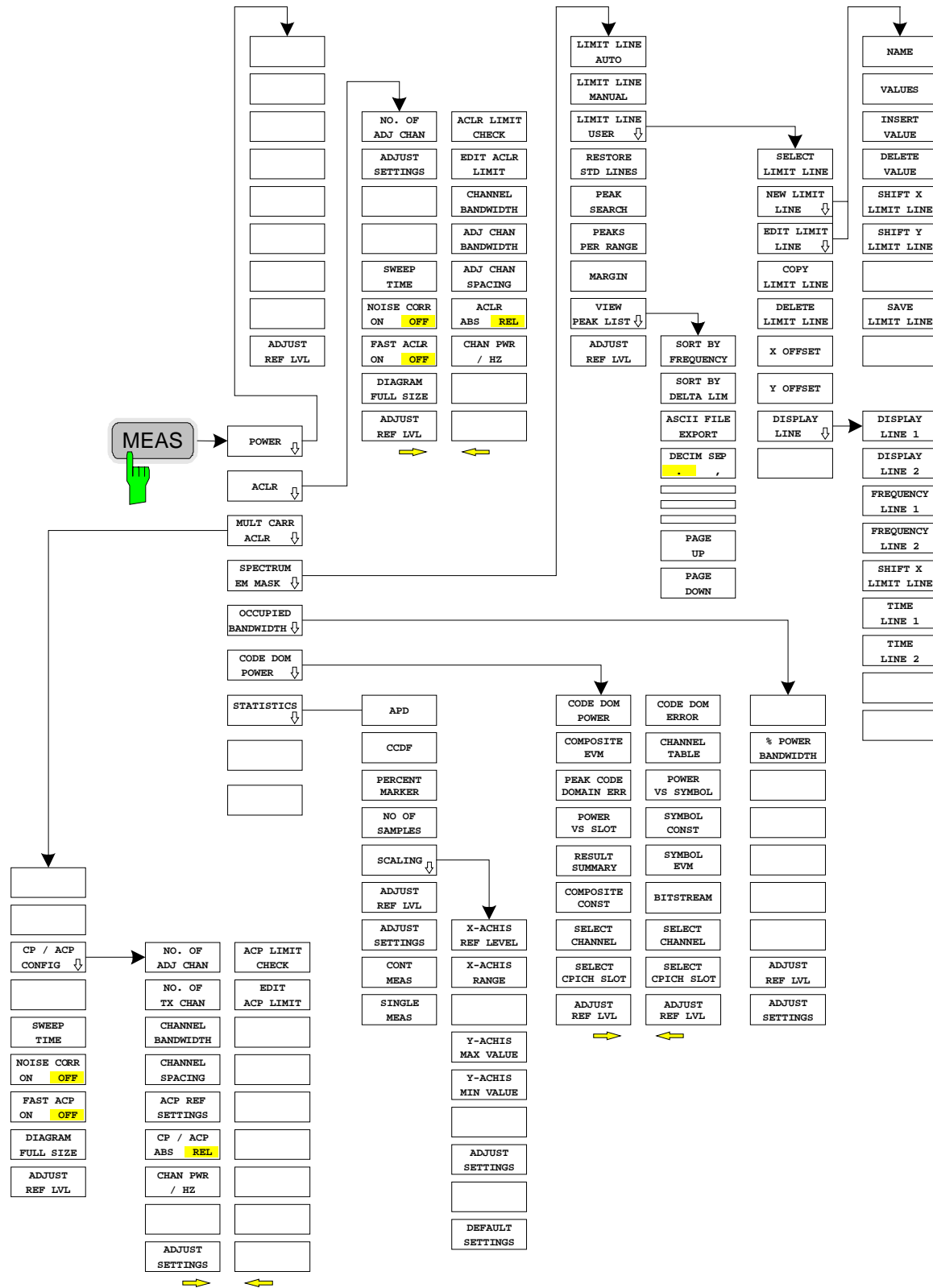

Fig. 5-2 Overview of menus - measurements

## 6 Configuration of 3GPP FDD Measurements

The most important parameters for the 3GPP FDD base station tests are summarized in the *MEAS* key submenu and explained below using the softkey functions. The measurements described for the softkeys can be performed both with an analyzer equipped with FS-K72 only and with an analyzer that also has FS-K74. The description of measurement functions and the corresponding graphics refer to FS-K72. If different behaviour for the measurement functions or additional information can be achieved by equipping the analyzer with FS-K72, this will be stated within the text.

The *CODE DOM POWER* softkey activates the code domain measurement mode and opens the submenus for setting the measurement. A change of the hotkey labels after the application has been started ensures that the most important parameters of the CDP (code domain power) measurements are directly accessible via the hotkey bar.

The *POWER*, *ACLR*, *SPECTRUM EM MASK*, *OCCUPIED BANDWIDTH* and *STATISTICS* softkeys activate base station tests in the analyzer mode. Pressing the associated softkey performs the settings required by 3GPP specifications. A subsequent modification of settings is possible. The other menus of the FSU correspond to the menus of this mode and are described in the operating manual for the FSU.

### CONFIGURATION MODE menu

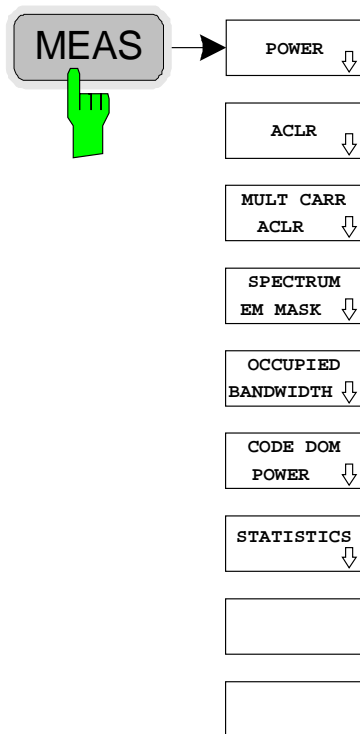

The *MEAS* key opens a submenu for setting the various measurement modes of option FS-K72/K74:

- *POWER* activates the channel power measurement with defined settings in the analyzer mode.
- *ACLR* activates the adjacent-channel power measurement with defined settings in the analyzer mode.
- *MULT CARR ACLR* activates the adjacent-channel power measurement for multi carrier signals with defined settings in the analyzer mode.
- *SPECTRUM EM MASK* compares the signal power in different carrier offset ranges with the maximum values specified by 3GPP.
- *OCCUPIED BANDWIDTH* activates the measurement of the occupied bandwidth (analyzer mode).
- *CODE DOM POWER* activates the code domain measurement mode and opens another submenu for selecting and configuring the parameters. All other menus of the FSU are adapted to the functions of the code domain measurement mode.
- *STATISTICS* evaluates the signal with regard to its statistical characteristics (distribution function of the signal amplitudes).

Measurement of Channel Power

MEAS key

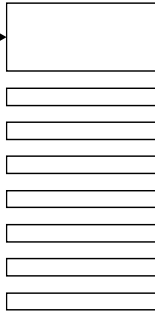
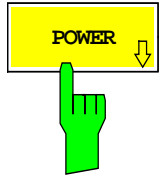

ADJUST  
REF LVL

The *POWER* softkey activates the measurement of the 3GPP FDD signal channel power.

The FSU measures the unweighted RF signal power in a bandwidth of:

$$f_{BW} = 5\text{ MHz} \geq (1 + \alpha) \cdot 3.84\text{ MHz} \quad | \quad \alpha = 0.22$$

The power is measured in zero span mode (time domain) using a digital channel filter of 5 MHz in bandwidth. According to the 3GPP standard, the measurement bandwidth (5 MHz) is slightly larger than the minimum required bandwidth of 4.7 MHz. The bandwidth is displayed numerically below the screen.

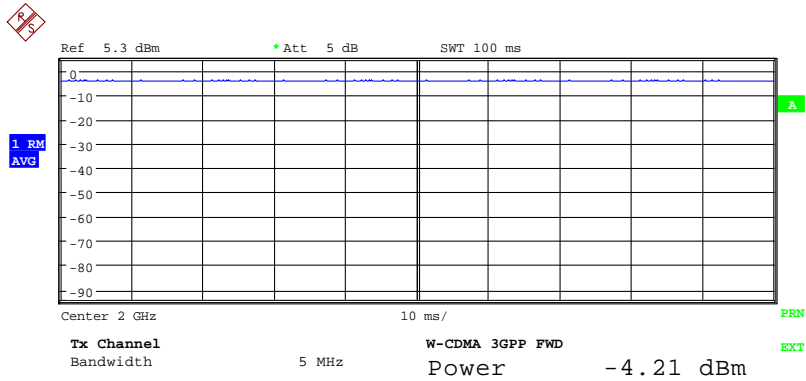

Fig. 6-1 Power measurement in the 3.84 MHz transmission channel

Pressing the softkey activates the analyzer mode with defined settings:

SYSTEM PRESET		
After PRESET, the following user-specific settings are restored, thus retaining the adaptation to the DUT: Reference Level, Reference Level Offset Center Frequency, Frequency Offset Input Attenuation, Mixer Level All trigger settings		
CHAN PWR / ACP	CP / ACP ON	
CP / ACP STANDARD	W-CDMA 3GPP FWD	
CP / ACP CONFIG	NO. OF ADJ CHAN	0

Starting from these settings, the FSU can be operated in all functions available in the analyzer mode, i.e. all test parameters can be adapted to the requirements of the specific measurement.

IEC/IEEE bus command: :CONFigure:WCDPower:MEASurement POWER

Query of results: :CALCulate:MARKer:FUNctio:n:POWER:RESult? CPower

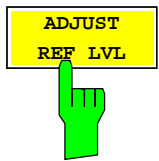

The *ADJUST REF LVL* softkey adapts the reference level of the FSU to the measured channel power. This ensures that the settings for the RF attenuation and reference level are optimally adapted to the signal level so that the FSU is not overdriven or the dynamic range reduced by too low an S/N ratio.

Since the measurement bandwidth for adjacent-channel power measurements is clearly narrower than the signal bandwidth, the signal path can be overdriven although the measured trace is definitely below the reference level.

IEC/IEEE bus command: SENS:POW:ACH:PRES:RLEV

### Measurement of Adjacent-Channel Power - ACLR

MEAS key

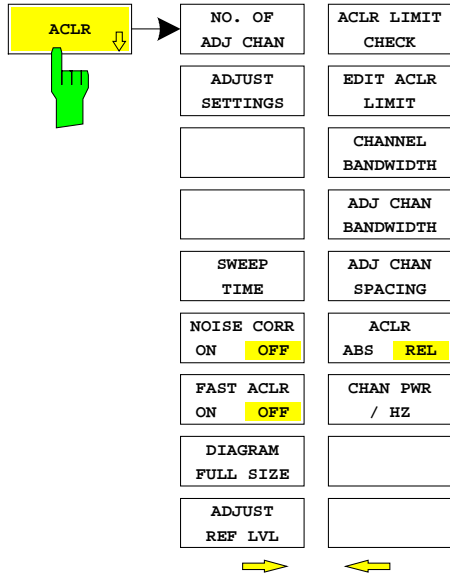

The ACLR softkey activates the adjacent-channel power measurement in the default setting according to 3GPP specifications (adjacent-channel leakage ratio).

The FSU measures the channel power and the relative power of the adjacent channels and of the alternate channels. The results are displayed below the screen.

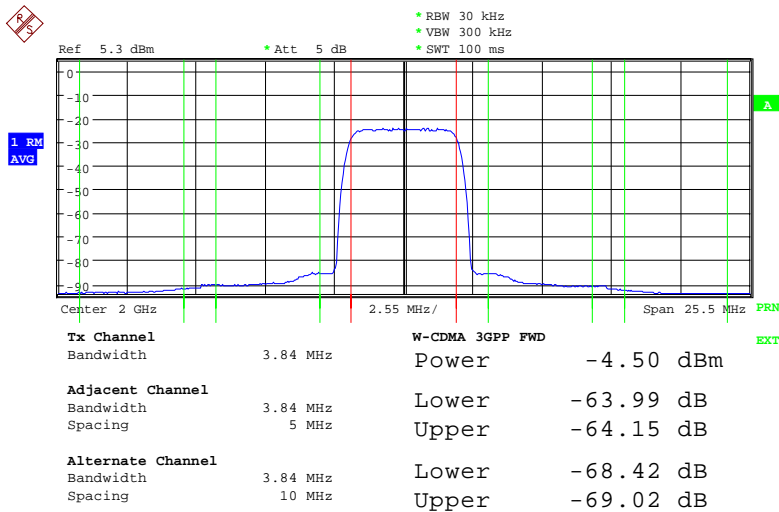

Fig. 6-2 Adjacent-channel power measurement of a 3GPP FDD base station

Pressing the softkey activates the analyzer mode with defined settings:

SYSTEM PRESET		
After PRESET the following user-specific settings are restored, thus retaining the adaptation to the DUT: Reference Level, Reference Level Offset Center Frequency, Frequency Offset Input Attenuation, Mixer Level All trigger settings		
CHAN PWR / ACP	CP / ACP ON	
CP / ACP STANDARD	W-CDMA 3GPP FWD	
CP / ACP CONFIG	NO. OF ADJ CHAN	2

IEC/IEEE bus command: :CONFigure:WCDPower:MEASurement ALCR

Query of results: :CALCulate:MARKer:FUNction:POWer:RESult? ACPower

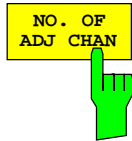

The *NO. OF ADJ CHAN* softkey activates the entry of the number  $\pm n$  of adjacent channels to be considered in the adjacent-channel power measurement. Numbers from 0 to 3 can be entered.

The following measurements are performed depending on the number of the channels.

- 0 Only the channel power is measured.
- 1 The channel power and the power of the upper and lower adjacent channels are measured.
- 2 The channel power, the power of the upper and lower adjacent channels and of the next higher and lower channels (alternate channel 1) are measured.
- 3 The channel power, the power of the upper and lower adjacent channels, the power of the next higher and lower channels (alternate channel 1) and of the next but one higher and lower adjacent channels (alternate channel 2) are measured.

IEC/IEEE bus command: POW:ACH:ACP 1

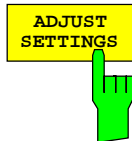

The *ADJUST SETTINGS* softkey automatically optimizes analyzer settings for the selected power measurement (see below). All analyzer settings relevant for power measurements within a specific frequency range (channel bandwidth) are optimally set depending on the channel configuration (channel bandwidth, channel spacing).

- Frequency span:  
The frequency span must cover at least all the channels that are to be considered. When the channel power is measured, the span is set to twice the channel bandwidth. The setting of the span for adjacent-channel power measurements depends on the channel spacing and the channel bandwidth of the adjacent channel with the largest distance from the transmission channel, ADJ, ALT1 or ALT2 .
- Resolution bandwidth RBW  $\leq 1/40$  of channel bandwidth
- Video bandwidth VBW  $\geq 3 \times$  RBW
- Detector RMS detector

The trace math and trace averaging functions are switched off. The reference level is not influenced by *ADJUST SETTINGS*. It can be separately adjusted with *ADJUST REF LVL*.

The adjustment is only carried out once; if necessary, the instrument settings can be changed later.

IEC/IEEE bus command: SENS:POW:ACH:PRES ACP|CPOW|OBW



The *SWEEP TIME* softkey activates entry of the sweep time. When the RMS detector is used, a longer sweep time yields more stable results. This setting is identical with the *SWEEP TIME MANUAL* setting in the *BW* menu.

IEC/IEEE bus command: `:SWE:TIM <value>`

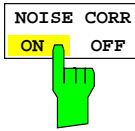

The *NOISE CORR ON/OFF* softkey switches on correction of measurement results by the residual instrument noise. When the softkey is switched on, first the residual instrument noise is measured. The measured noise is then deducted from the power in the observed channel.

Each time the measurement frequency, the resolution bandwidth, the measurement time or the level settings are changed, noise correction is switched off. To repeat the residual noise measurement with the new settings, the softkey must be pressed again.

IEC/IEEE bus command: `SENS:POW:NCOR ON`

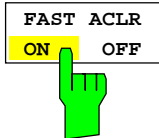

The *FAST ACLR* softkey toggles between the measurement in line with the IBW method (*FAST ACLR OFF*) and the measurement in the time domain (*FAST ACLR ON*).

With *FAST ACLR ON* selected, the power is measured in the various channels in the time domain. The FSU sets its center frequency to the different channel center frequencies one after the other, and then measures the power at these frequencies with the set measurement time (= sweep time/number of measured channels). Suitable RBW filters are automatically used for the selected standard and frequency offset (root raised cosine at WCDMA).

The RMS detector is used for a correct power measurement. Software correction factors are not required in this case.

Measured values are output in a table; the power of the useful channel is specified in dBm and the power of the adjacent channels in dBm (*ACLR ABS*) or dB (*ACLR REL*).

The selected sweep time (=measurement time) depends on the desired reproducibility of measurement results. The longer the selected sweep time, the better the reproducibility of results because, in this case, the power is measured over a longer period of time.

As a rule of thumb, it can be assumed that approx. 500 uncorrelated values are required for a reproducibility of 0.5 dB (99% of the measurements are within 0.5 dB of the true measured value). Measured values are considered uncorrelated if their time spacing corresponds to the reciprocal of the measurement bandwidth.

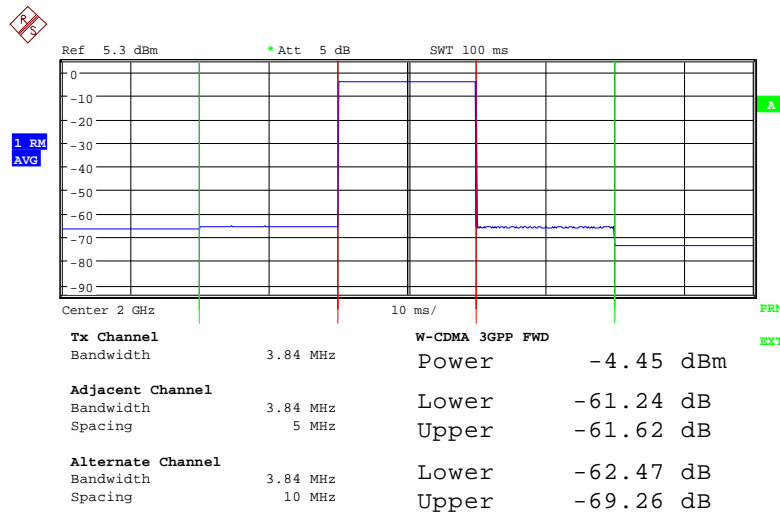

IEC/IEEE bus command: `SENS:POW:HSP ON`



DIAGRAM  
FULL SIZE



The *DIAGRAM FULL SIZE* softkey switches the diagram to full screen size.

IEC/IEEE bus command: -

ADJUST  
REF LVL



The *ADJUST REF LVL* softkey adapts the reference level of the FSU to the measured channel power. This ensures that the settings for the RF attenuation and reference level are optimally adapted to the signal level so that the FSU is not overdriven or the dynamic range reduced by too low an S/N ratio.

Since the measurement bandwidth for adjacent-channel power measurements is clearly narrower than the signal bandwidth, the signal path can be overdriven although the measured trace is definitely below the reference level.

IEC/IEEE bus command: SENS:POW:ACH:PRES:RLEV

ACLR LIMIT  
CHECK



The *ACLR LIMIT CHECK* softkey switches the limit check for the ACLR measurement on or off.

IEC/IEEE bus command: :CALC:LIM:ACP ON

Query of LIMIT CHECK results for

Adjacent channel: :CALC:LIM:ACP:ACH:RES?

Alternate channel <1..2>: :CALC:LIM:ACP:ALT<1..2>:RES?

Result format:

Left sideband [ PASSED , FAILED ]

Right sideband [ PASSED , FAILED ]



EDIT ACLR LIMIT opens a table with limits for the ACLR measurement. The standard-specific default values are entered with the ADJUST SETTINGS softkey.

ACP LIMITS				
CHAN	RELATIVE LIMIT CHECK		ABSOLUTE LIMIT CHECK	
	VALUE	ON	VALUE	ON
ADJ	-55 dBc	*	0 dBm	
ALT1	-70 dBc	*	0 dBm	
ALT2	0 dBc		0 dBm	

The following rules apply for limit values:

- A limit value can be defined for each of the adjacent channels. The limit value applies to the upper and the lower adjacent channel.
- A relative limit value and/or an absolute limit can be defined. The check can be activated separately for the two limit values.
- Compliance with active limit values is checked irrespective of whether absolute or relative limits are specified or whether the measurement itself is performed with absolute levels or a relative level ratio. If the two checks are active and the higher one of the two levels is exceeded, the respective value will be marked.

**Note:** Measured values violating the limit are printed in red and preceded by a red asterisk.

```
IEC/IEEE bus command: :CALC:LIM:ACP ON
                        :CALC:LIM:ACP:ACH 0dB,0dB
                        :CALC:LIM:ACP:ACH:STAT ON
                        :CALC:LIM:ACP:ACH:ABS -10dBm,-10dBm
                        :CALC:LIM:ACP:ACH:ABS:STAT ON
                        :CALC:LIM:ACP:ALT1 0dB,0dB
                        :CALC:LIM:ACP:ALT1:STAT ON
                        :CALC:LIM:ACP:ALT1:ABS -10dBm,-10dBm
                        :CALC:LIM:ACP:ALT1:ABS:STAT ON
                        :CALC:LIM:ACP:ALT2 0dB,0dB
                        :CALC:LIM:ACP:ALT2:STAT ON
                        :CALC:LIM:ACP:ALT2:ABS -10dBm,-10dBm
                        :CALC:LIM:ACP:ALT2:ABS:STAT ON
```

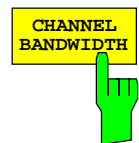

The CHANNEL BANDWIDTH softkey activates the entry of the channel bandwidth for the transmission channel.

The useful channel bandwidth is generally defined by the transmission method. In the WCDMA default setting, measurements are performed with a channel bandwidth of 3.84 MHz.

When measuring according to the IBW method (FAST ACP OFF), the channel bandwidth is marked by two vertical lines to the left and right of the screen center. It can thus be visually checked whether the entire power of the signal to be measured is within the selected channel bandwidth.

With the time domain method (FAST ACP ON) the measurement is performed in zero span. The channel limits are not marked in this case. The FSU offers all available channel filters for selection of the channel bandwidth. Deviating channel bandwidths cannot be set. If deviating channel bandwidths are required, the IBW method should be used.

```
IEC/IEEE bus command: SENS:POW:ACH:BWID 3.84MHz
```

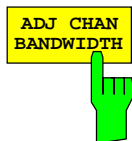

The ADJ *CHAN BANDWIDTH* softkey opens a table in which the channel bandwidths for the adjacent channels can be defined.

ACP CHANNEL BW	
CHAN	BANDWIDTH
ADJ	3.84 MHz
ALT1	3.84 MHz
ALT2	3.84 MHz

When measuring according to the IBW method (FAST ACP OFF), the bandwidths of the different adjacent channels are to be entered numerically. Since all adjacent channels often have the same bandwidth, the other channels ALT1 and ALT2 are set to the bandwidth of the adjacent channel on entering the adjacent-channel bandwidth (ADJ). Thus only one value needs to be entered in the case of equal adjacent channel bandwidths. The same holds true for the ALT2 channels (alternate channels 2) when the bandwidth of the ALT1 channel (alternate channel 1) is entered.

**Note:** The bandwidths can be selected independently of each other by overwriting the table from top to bottom.

With the time domain method (FAST ACP ON), the adjacent-channel bandwidths are selected from the list of available channel filters. For deviating adjacent-channel bandwidths, the IBW method should be used.

IEC/IEEE bus command: SENS:POW:ACH:BWID:ACH 3.84MHz  
 SENS:POW:ACH:BWID:ALT1 3.84MHz  
 SENS:POW:ACH:BWID:ALT2 3.84MHz

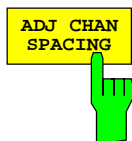

The ADJ *CHAN SPACING* softkey opens a table for defining the channel spacings.

ACP CHANNEL SPACING	
CHAN	SPACING
ADJ	5 MHz
ALT1	10 MHz
ALT2	15 MHz

Since all adjacent channels often have the same distance to each other, the entry of the adjacent-channel spacing (ADJ) causes channel spacing ALT1 to be set to twice and channel spacing ALT2 to three times the adjacent-channel spacing. Thus only one value needs to be entered in the case of equal channel spacing. The same holds true for the ALT2 channels when the bandwidth of the ALT1 channel is entered.

**Note:** The channel spacings can be set separately by overwriting the table from top to bottom.

IEC/IEEE bus command: SENS:POW:ACH:SPAC:ACH 5MHz  
 SENS:POW:ACH:SPAC:ALT1 10MHz  
 SENS:POW:ACH:SPAC:ALT2 15MHz

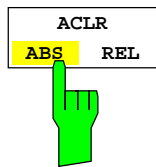

The *CP/ACP ABS/REL* softkey (channel power absolute/relative) switches between absolute and relative power measurement in the channel.

**ACLR ABS** The absolute power in the transmission channel and in the adjacent channels is displayed in the unit of the Y axis, e.g. in dBm.

**ACLR REL** In the case of adjacent-channel power measurements (*NO. OF ADJ CHAN > 0*), the level of the adjacent channels is displayed relative to the level of the transmission channel in dBc. With linear scaling of the Y axis, the power of the new channel is displayed relative to the reference channel ( $CP/CP_{ref}$ ). With dB scaling, the logarithmic ratio  $10\lg(CP/CP_{ref})$  is displayed. The relative channel power measurement can thus also be used for universal adjacent-channel power measurements. Each channel can be measured individually.

IEC/IEEE bus command: `SENS:POW:ACH:MODE ABS`

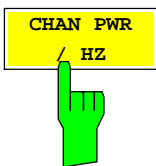

The *CHAN PWR / HZ* softkey switches between the measurement of the total power in the channel and the power measurement with reference to 1 Hz bandwidth.

The conversion factor is  $10 \cdot \lg \frac{1}{\text{Channel} \cdot \text{Bandwidth}}$ .

IEC/IEEE bus command: `:CALC:MARK:FUNC:POW:RES:PHZ ON|OFF`

For manual setting of test parameters differing from the settings made with *ADJUST SETTINGS*, the following should be observed:

**Frequency span** The frequency span has to cover at least all channels to be measured. This is the channel bandwidth for channel power measurement. If the frequency span is large compared to the frequency section (or frequency sections) under test, only a few pixels are available to be measured.

**Resolution bandwidth (RBW)** To ensure both an acceptable measurement speed and the required selection (to suppress spectral components outside the channel to be measured, especially of the adjacent channels), the resolution bandwidth that is selected must not be too small or too large. As a general approach, the resolution bandwidth is to be set to values between 1% and 4% of the channel bandwidth. A larger resolution bandwidth can be selected if the spectrum within the channel to be measured and around it has a flat characteristic.

**Video bandwidth (VBW)** For a correct power measurement, the video signal must not be limited in bandwidth. A restricted bandwidth of the logarithmic video signal would cause signal averaging and thus result in a power indication that is too low (-2.51 dB at very low video bandwidths). The video bandwidth should therefore be selected at least three times the resolution bandwidth. The *ADJUST SETTINGS* softkey sets the video bandwidth (VBW) as a function of the channel bandwidth as follows:

$$VBW \geq 3 \times RBW.$$

**Detector** The *ADJUST SETTINGS* softkey selects the RMS detector. The RMS detector is selected since it correctly indicates the power irrespective of the characteristics of the signal to be measured. In principle, the sample detector would be possible as well. Due to the limited number of trace pixels used to calculate the power in the channel, the sample detector would yield less stable results. Averaging, which is often performed to stabilize the measurement results, leads to an indication level that is too low and should therefore be avoided. The reduction in the displayed power depends on the number of averages and the signal characteristics in the channel to be measured.

Measurement of Multi Carrier Adjacent-Channel Power – MULT CARR ACLR

MEAS key

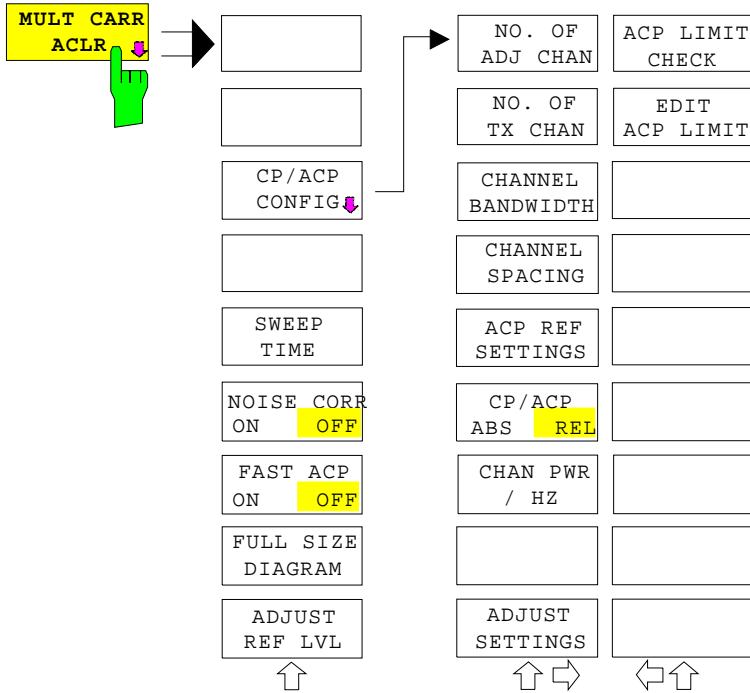

The *MULT CARR ACP* softkey activates adjacent-channel power measurement for several carrier signals. In addition, it opens a submenu for defining the parameters for channel power measurement. The softkey selected is shown in colour to indicate that an adjacent-channel power measurement is active.

IEC/IEEE-bus command:  
:CONF:WCDP:MEAS MCAC

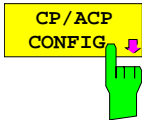

The *CP/ACP CONFIG* softkey opens a submenu for defining the parameters for MULT CARR ACLR measurement. The submenu is identical to the same one in analyzer mode. Please refer to analyzer manual for a description of the submenu.

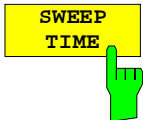

The *SWEEP TIME* softkey activates the entry of the sweep time. With the RMS detector, a longer sweep time increases the stability of the measurement results. The function of the softkey is identical to the softkey *SWEEP TIME MANUAL* in the menu *BW*.

IEC/IEEE-bus command: SWE:TIM <value>

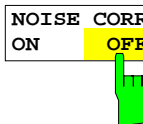

If the *NOISE CORR ON/OFF* softkey is activated, the results will be corrected by the instrument's inherent noise, which increases the dynamic range. When the function is switched on, a reference measurement of the instrument's inherent noise is carried out. The noise power measured is then subtracted from the power in the channel that is being examined. The inherent noise of the instrument depends on the selected center frequency, resolution bandwidth and level setting. Therefore, the correction function is disabled whenever one of these parameters is changed. A disable message is displayed on the screen. To enable the correction function in conjunction with the changed setting, press the softkey once more. A new reference measurement is carried out.

IEC/IEEE-bus command: SENS:POW:NCOR ON

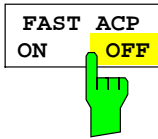

The *FAST ACP* softkey switches between the IBW method (*FAST ACP OFF*) and the time domain method (*FAST ACP ON*).

With *FAST ACP ON* the power measurement is performed in the different channels in the time domain. The analyzer sets the center frequency consecutively to the different channel center frequencies and measures the power with the selected measurement time (= sweep time/number of channels). The RBW filters suitable for the selected standard and frequency offset are automatically used (e.g. root raised cos with W-CDMA). The list of available channel filters is included in section "Setting of Bandwidths and Sweep Time – *BW key*".

The RMS detector is used for obtaining correct power measurement results. Therefore this requires no software correction factors.

Measured values are output as a list. The powers of the transmission channels are output in dBm, the powers of the adjacent channels in dBm (*CP/ACP ABS*) or dB (*CP/ACP REL*).

The sweep time is selected depending on the desired reproducibility of results. Reproducibility increases with sweep time since power measurement is then performed over a longer time period.

As a general approach, it can be assumed that approx. 500 non-correlated measured values are required for a reproducibility of 0.5 dB (99% of the measurements are within 0.5 dB of the true measured value). This holds true for white noise. The measured values are considered as non-correlated when their time interval corresponds to the reciprocal of the measured bandwidth.

IEC/IEEE-bus command            `SENS:POW:HSP ON`

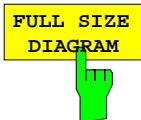

The *FULL SIZE DIAGRAM* softkey switches the diagram to full screen size.

IEC/IEEE-bus command:            `DISP:WIND1:SIZE LARG|SMAL-`

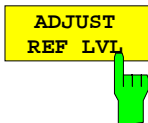

The *ADJUST REF LVL* softkey adjusts the reference level of the instrument to the measured channel power. This ensures that the settings of the RF attenuation and the reference level are optimally adjusted to the signal level without overloading the instrument or limiting the dynamic range by a too small S/N ratio.

Since the measurement bandwidth for channel power measurements is significantly lower than the signal bandwidth, the signal path may be overloaded although the trace is still significantly below the reference level.

IEC/IEEE-bus command:            `SENS:POW:ACH:PRES:RLEV`

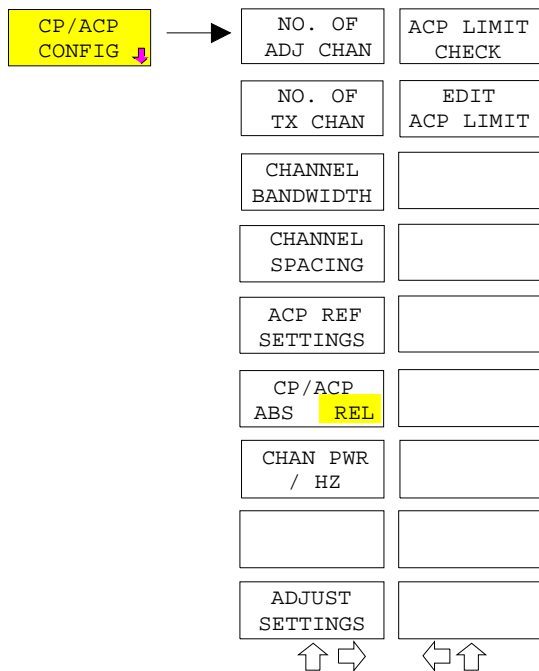

The *CP/ACP CONFIG* softkey opens a submenu for configuration of the channel power and adjacent channel power measurement independently of the offered standards.

The channel configuration includes the number of channels to be measured, the channel bandwidths (*CHANNEL BANDWIDTH*), and the channel spacings (*CHANNEL SPACING*).

Limit values can additionally be specified for the adjacent-channel power (*ACP LIMIT CHECK* and *EDIT ACP LIMITS*) which are checked for compliance during the measurement.



The *NO. OF ADJ CHAN* softkey activates the entry of the number  $\pm n$  of adjacent channels to be considered in the adjacent-channel power measurement. Numbers from 0 to 3 can be entered.

The following measurements are performed depending on the number of the channels.

- 0 Only the channel powers are measured.
- 1 The channel powers and the power of the upper and lower adjacent channel are measured.
- 2 The channel powers, the power of the upper and lower adjacent channel and of the next higher and lower channel (alternate channel 1) are measured.
- 3 The channel power, the power of the upper and lower adjacent channel, the power of the next higher and lower channel (alternate channel 1) and of the next but one higher and lower adjacent channel (alternate channel 2) are measured.

IEC/IEEE-bus command: POW:ACH:ACP 1

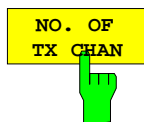

The *NO. OF TX CHAN* softkey enables the entry of the number of carrier signals to be considered in channel and adjacent-channel power measurements.

Numbers from 1 to 12 can be entered.

The softkey is available only for multicarrier ACP measurements.

IEC/IEEE-bus command: SENS:POW:ACH:TXCH:COUN 4

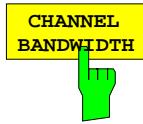

The *CHANNEL BANDWIDTH* softkey opens a table for defining the channel bandwidths for the transmission channels and the adjacent channels.

ACP CHANNEL BW	
CHAN	BANDWIDTH
ADJ	14 kHz
ALT1	14 kHz
ALT2	14 kHz

The transmission-channel bandwidth is normally defined by the transmission standard. The correct bandwidth is set automatically for the selected standard (see *CP/ACP STANDARD* softkey).

With the IBW method (*FAST ACP OFF*), the channel bandwidth limits are marked by two vertical lines right and left of the channel center frequency. It can in this way be visually checked whether the entire power of the signal under test is within the selected channel bandwidth.

Measurements in the time domain (*FAST ACP ON*) are performed in the zero span mode. The channel limits are indicated by vertical lines. For measurements requiring channel bandwidths deviating from those defined in the selected standard the IBW method is to be used.

Refer to section "Setting of Bandwidths and Sweep Time – *BW* key" for a list of available channel filters.

When measuring according to the IBW method (*FAST ACP OFF*) the bandwidths of the different adjacent channels are to be entered numerically. Since all adjacent channels often have the same bandwidth, the other channels Alt1 and Alt2 are set to the bandwidth of the adjacent channel on entering the adjacent-channel bandwidth (ADJ). Thus only one value needs to be entered in case of equal adjacent channel bandwidths. The same holds true for the ALT2 channels (alternate channels 2) when the bandwidth of the ALT1 channel (alternate channel 1) is entered.

**Note:** *The channel spacings can be set separately by overwriting the table from top to bottom.*

```
IEC/IEEE-bus command: POW:ACH:BWID:CHAN 3.84MHz
                      POW:ACH:BWID:ACH 3.84MHz
                      POW:ACH:BWID:ALT1 3.84MHz
                      POW:ACH:BWID:ALT2 3.84MHz
```



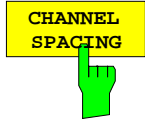

The CHANNEL SPACING softkey opens a table for defining the channel spacings.

ACP CHANNEL SPACING	
CHAN	SPACING
ADJ	20 kHz
ALT1	40 kHz
ALT2	60 kHz

Since all the adjacent channels often have the same distance to each other, the entry of the adjacent-channel spacing (ADJ) causes channel spacing ALT1 to be set to twice and channel spacing ALT2 to three times the adjacent-channel spacing. Thus only one value needs to be entered in case of equal channel spacing. The same holds true for the ALT2 channels when the bandwidth of the ALT1 channel is entered.

**Note:** The channel spacings can be set separately by overwriting the table from top to bottom.  
The entry "TX" is only available for the multicarrier ACP measurement.

IEC/IEEE-bus command: SENS:POW:ACH:SPAC:CHAN 5MHz  
SENS:POW:ACH:SPAC:ACH 5MHz  
SENS:POW:ACH:SPAC:ALT1 10MHz  
SENS:POW:ACH:SPAC:ALT2 15MHz

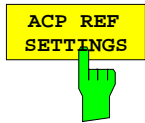

The ACP REF SETTINGS softkey opens a table for selecting the transmission channel to which the adjacent-channel relative power values should be referenced.

ACP REFERENCE CHANNEL	
<input checked="" type="checkbox"/>	TX CHANNEL 1
<input type="checkbox"/>	TX CHANNEL 2
<input type="checkbox"/>	TX CHANNEL 3
<input type="checkbox"/>	TX CHANNEL 4
<input type="checkbox"/>	MIN POWER TX CHANNEL
<input type="checkbox"/>	MAX POWER TX CHANNEL
<input type="checkbox"/>	LOWEST & HIGHEST CHANNEL

TX CHANNEL 1 - 4 Selection of one of channels 1 to 4.  
MIN POWER TX CHANNEL The transmission channel with the lowest power is used as a reference channel.  
MAX POWER TX CHANNEL The transmission channel with the highest power is used as a reference channel.  
LOWEST & HIGHEST CHANNEL The outer lefthand transmission channel is the reference channel for the lower adjacent channels, the outer righthand transmission channel that for the upper adjacent channels.

**Note:** The softkey is only available for the multicarrier ACP measurement.

IEC/IEEE-bus command: POW:ACH:REF:TXCH:MAN 1  
POW:ACH:REF:TXCH:AUTO MIN

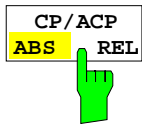

The *CP/ACP ABS/REL* softkey (channel power absolute/relative) switches between absolute and relative power measurement in the channel.

*CP/ACP ABS* The absolute power in the transmission channel and in the adjacent channels is displayed in the unit of the Y axis, e.g. in dBm, dBμV.

*CP/ACP REL* For adjacent-channel power measurements (*NO. OF ADJ CHAN* > 0), the level of the adjacent channels is displayed relative to the level of the transmission channel in dBc.

For channel power measurements (*NO. OF ADJ CHAN* = 0) with a single carrier, the power of the transmission channel is displayed relative to the power of a reference channel defined by *SET CP REFERENCE*. This means:

1. Declare the power of the currently measured channel as the reference value, using the *SET CP REFERENCE* softkey.
2. Select the channel of interest by varying the channel frequency center frequency).

With linear scaling of the Y axis, the power of the new channel relative to the reference channel ( $CP/CP_{ref}$ ) is displayed. With dB scaling, the logarithmic ratio  $10\lg(CP/CP_{ref})$  is displayed.

The relative channel power measurement can thus also be used for universal adjacent-channel power measurements. Each channel can be measured individually.

IEC/IEEE-bus command: `POW:ACH:MODE ABS`

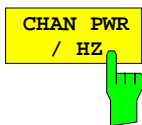

The *CHAN PWR / HZ* softkey toggles between the measurement of the total channel power and the measurement of the channel power referenced to a 1-Hz bandwidth.

The conversion factor is  $10 \cdot \lg \frac{1}{\text{Channel} \cdot \text{Bandwidth}}$ .

By means of this function it is possible e.g. to measure the signal/noise power density or use the additional functions *CP/ACP REL* and *SET CP REFERENCE* to obtain the signal to noise ratio.

IEC/IEEE-bus command: `CALC:MARK:FUNC:POW:RES:PHZ ON|OFF`

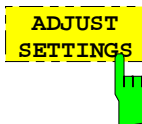

The *ADJUST SETTINGS* softkey automatically optimizes the instrument settings for the selected power measurement (see below).

All instrument settings relevant for a power measurement within a specific frequency range (channel bandwidth) are optimized for the selected channel configuration (channel bandwidth, channel spacing):

- Frequency span:

The frequency span should cover at least all channels to be considered in a measurement.

For adjacent-channel power measurements, the frequency span is set as a function of the number of transmission channels, the transmission channel spacing, the adjacent-channel spacing, and the bandwidth of one of adjacent-channels *ADJ*, *ALT1* or *ALT2*, whichever is furthest away from the transmission channels:

IEC/IEEE-bus command: `POW:ACH:PRES MCAC`

The *ACP LIMIT CHECK* softkey switches the limit check for the ACP measurement on and off.

IEC/IEEE-bus command:            `CALC:LIM:ACP ON`  
    `CALC:LIM:ACP:ACH:RES?`  
    `CALC:LIM:ACP:ALT:RES?`

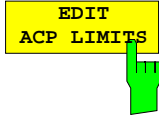

The *EDIT ACP LIMITS* softkey opens a table for defining the limits for the ACP measurement.

ACP LIMITS				
CHAN	RELATIVE LIMIT CHECK		ABSOLUTE LIMIT CHECK	
	VALUE	ON	VALUE	ON
ADJ	-45 dB	√		
ALT1	-60 dB	√		
ALT2				

The following rules apply for the limits:

- A separate limit can be defined for each adjacent channel. The limit applies to both the upper and the lower adjacent channel.
- A relative and/or absolute limit can be defined. The check of both limit values can be activated independently.
- The checks adherence to the limits irrespective of whether the limits are absolute or relative or whether the measurement is carried out with absolute or relative levels. If both limits are active and if the higher of both limit values is exceeded, the measured value is marked accordingly.

**Note:** *Measured values exceeding the limit are marked by a preceding asterisk.*

IEC/IEEE-bus command:  
    `CALC:LIM:ACP ON`  
    `CALC:LIM:ACP:ACH 0dB,0dB`  
    `CALC:LIM:ACP:ACH:STAT ON`  
    `CALC:LIM:ACP:ACH:ABS -10dBm,-10dBm`  
    `CALC:LIM:ACP:ACH:ABS:STAT ON`  
    `CALC:LIM:ACP:ALT1 0dB,0dB`  
    `CALC:LIM:ACP:ALT1:STAT ON`  
    `CALC:LIM:ACP:ALT1:ABS -10dBm,-10dBm`  
    `CALC:LIM:ACP:ALT1:ABS:STAT ON`  
    `CALC:LIM:ACP:ALT2 0dB,0dB`  
    `CALC:LIM:ACP:ALT2:STAT ON`  
    `CALC:LIM:ACP:ALT2:ABS -10dBm,-10dBm`  
    `CALC:LIM:ACP:ALT2:ABS:STAT ON`

### Signal Power Check – SPECTRUM EM MASK

MEAS key

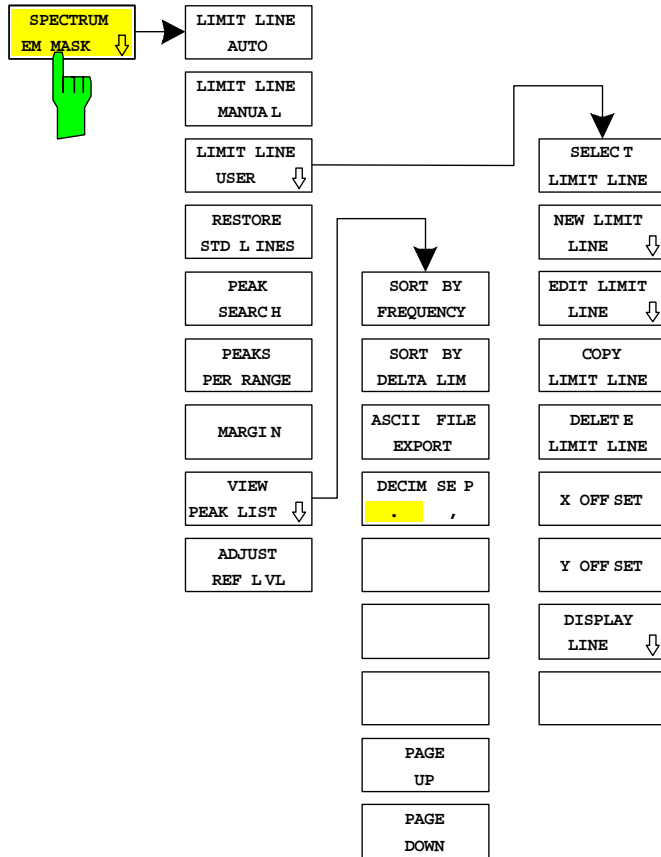

The *SPECTRUM EM MASK* softkey starts the determination of the power of the 3GPP FDD signal in defined offsets from the carrier and compares the power values with a spectral mask specified by 3GPP.

IEC/IEEE bus command:  
:CONFigure:WCDPower:MEASurement  
ESpectrum

Query of results:  
:CALCulate:LIMit:FAIL? and visual evaluation

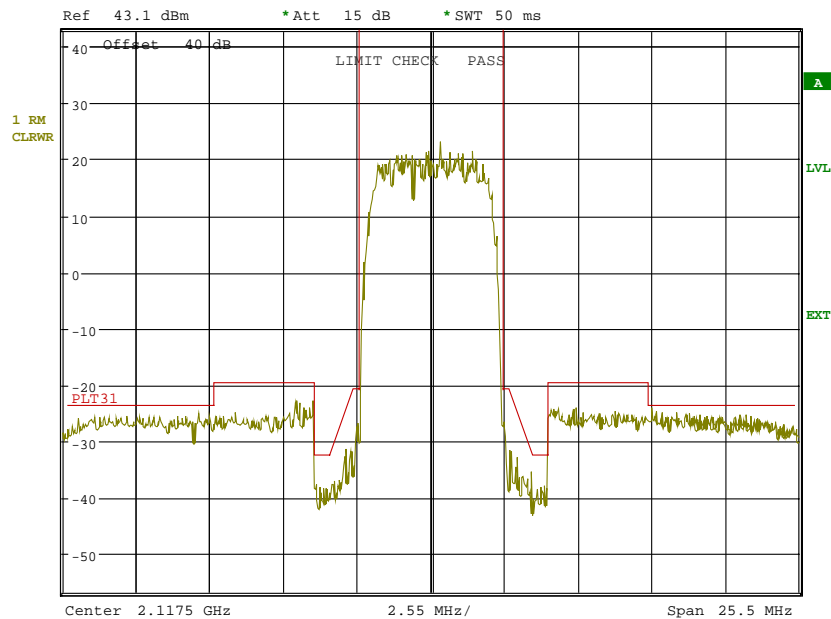

Fig. 6-3 Measurement of spectrum emission mask

Pressing the softkey activates the analyzer mode with defined settings:

SYSTEM PRESET		
After PRESET the following user-specific settings are restored, thus retaining the adaptation to the DUT: Reference Level, Reference Level Offset Center Frequency, Frequency Offset Input Attenuation, Mixer Level All trigger settings		
CHAN PWR / ACP	CP / ACP ON	
CP / ACP STANDARD	W-CDMA 3GPP REV	
CP / ACP CONFIG	NO. OF ADJ CHAN	0
SPAN		25.5 MHz
BW	SWEEP TIME MANUAL	50 ms

LIMIT LINE  
AUTO



The LIMIT LINE AUTO softkey automatically selects the limit line to be checked according to the power determined in the useful channel. If the measurement is carried out in CONTINUOUS SWEEP and the channel power changes from sweep to sweep, this can result in the limit line being continuously redrawn.

The softkey is activated when the spectrum emission mask measurement is entered.

IEC/IEEE bus command: `:CALC:LIM:ESP:MODE AUT`

LIMIT LINE  
MANUAL



The LIMIT LINE MANUAL softkey activates the manual selection of a predefined limit line. If this softkey is selected, the channel power measurement is not used to select the limit line, but only to determine its relative components. The power at the different frequency offsets is compared with the user-defined limit line.

The softkey opens a table with all the limit lines predefined in the device:

P >= 43 dBm  
39 dBm <= P < 43 dBm  
31 dBm <= P < 39 dBm  
P < 31 dBm

The name of the limit line indicates the expected power range for which the limit line has been defined.

IEC/IEEE bus command: `:CALC:LIM:ESP:MODE MANua1`  
`:CALC:LIM:ESP:VALue 39`

LIMIT LINE  
USER



The LIMIT LINE USER softkey activates the input of user-defined limit lines. The softkey opens the menus of the limit line editor that are known from the base unit.

In contrast to the predefined limit lines supplied with the FSU which correspond to the standard specifications, the user-defined limit line can be specified for the entire frequency range ( $\pm 12.5$  MHz from carrier) either relatively (referenced to the channel power) or absolutely.

IEC/IEEE bus command:  
`:CALCulate:LIMit<1>:NAME <string>`  
`:CALCulate:LIMit<1>:UNIT DBM`  
`:CALCulate:LIMit<1>:CONTRol[:DATA]`  
`<num_value>, <num_value>, ...`  
`:CALCulate:LIMit<1>:CONTRol:DOMain FREQuency`  
`:CALCulate:LIMit<1>:CONTRol:TRACe 1`  
`:CALCulate:LIMit<1>:CONTRol:OFFset <num_value>`  
`:CALCulate:LIMit<1>:CONTRol:MODE RELative`  
`:CALCulate:LIMit<1>:UPPer[:DATA]`

```

<num_value>, <num_value>..
:CALCulate:LIMit<1>:UPPer:STATE    ON | OFF
:CALCulate:LIMit<1>:UPPer:OFFset  <num_value>
:CALCulate:LIMit<1>:UPPer:MARGin  <num_value>
:CALCulate:LIMit<1>:UPPer:MODE    ABSolute
:CALCulate:LIMit<1>:UPPer:SPACing LINear
    
```



The *RESTORE STD LINES* softkey restores the limit lines defined in the standard to the factory-set state. This prevents inadvertent overwriting of the standard lines.

```

IEC/IEEE bus command:      :CALC:LIM:ESP:RESTore
    
```



The *PEAK SEARCH* softkey activates a single measurement of spectrum emission mask. The limit mask - reduced by an overall margin - is checked against the trace. The fail positions are marked by crosses. Every value is added to a peak list which can be opened and saved in ASCII format or read out via an IEC/IEEE command.

The peaks are calculated using the same peak search algorithm like markers do. It is possible to define the peak excursion value via *MKR->NEXT*, softkey *PEAK EXCURSION*. Additionally the worst fail of each fail area without a peak is marked and added to the peak list.

```

IEC/IEEE bus command:      :CALC:PEAK
    
```



The *PEAKS PER RANGE* softkey defines how many peaks are searched for within one range. The ranges are:

- below -4 MHz from the carrier,
- above +4 MHz from carrier, and
- the area from -4 MHz to +4 MHz around the carrier.

The default value of *PEAKS PER RANGE* is 25.

```

IEC/IEEE bus command:      :CALC:PEAK:SUBR 1...50
    
```



The *MARGIN* softkey defines an overall margin which is subtracted from the limit line to make the peak search more stronger. If the values of the trace are above the limit line minus margin value it will be marked with a cross as shown in the peak list. The *DELTA LIMIT* of the list will be positive thus indicating that only the margin and not the limit itself is reached. A negative sign would indicate the real fail. The default value of *MARGIN* is 6 dB.

```

IEC/IEEE bus command:      :CALC:PEAK:MARG -200dB...200dB
    
```





The *ASCII FILE EXPORT* softkey exports the peak list in ASCII format to a file. The complete output format is similar to the trace export. The peak values within the file are comma separated in the format:

```
<trace no 1>, <freq1>, <level1>, <delta level 1>,
<trace no 2>, <freq2>, <level2>, <delta level 2>,
...
```

The trace no is always 1.

IEC/IEEE bus command: `:MMEM:STOR:FIN 'A:\final.dat'`

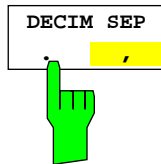

Different language versions of evaluation programs may require a different handling of the decimal point. It is therefore possible to select between default separators '.' (decimal point) and ',' (comma) using softkey *DECIM SEP*.

IEC/IEEE bus command: `:FORM:DEXP:DSEP POIN | COMM`

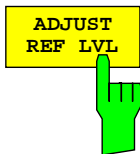

The *ADJUST REF LVL* softkey adjusts the FSU reference level to the total signal power measured.

The softkey becomes active after the first sweep has been terminated with the measurement of the occupied bandwidth and the total signal power is known.

The adjustment of the reference level ensures that the FSU signal path is not overdriven and that the dynamic range is not limited by a reference level that is too low.

IEC/IEEE bus command: `SENS:POW:ACH:PRES:RLEV`



### Measurement of Occupied Bandwidth - OCCUPIED BANDWIDTH

MEAS key

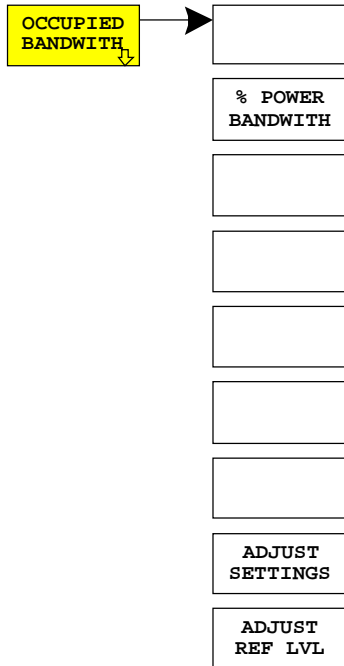

The *OCCUPIED BANDWIDTH* activates the measurement of the bandwidth that the signal occupies.

The occupied bandwidth is defined as the bandwidth in which – in default settings – 99% of the total signal power is to be found. The percentage of the signal power to be included in the bandwidth measurement can be changed.

The occupied bandwidth and the frequency markers are output in the marker info field at the top right edge of the screen.

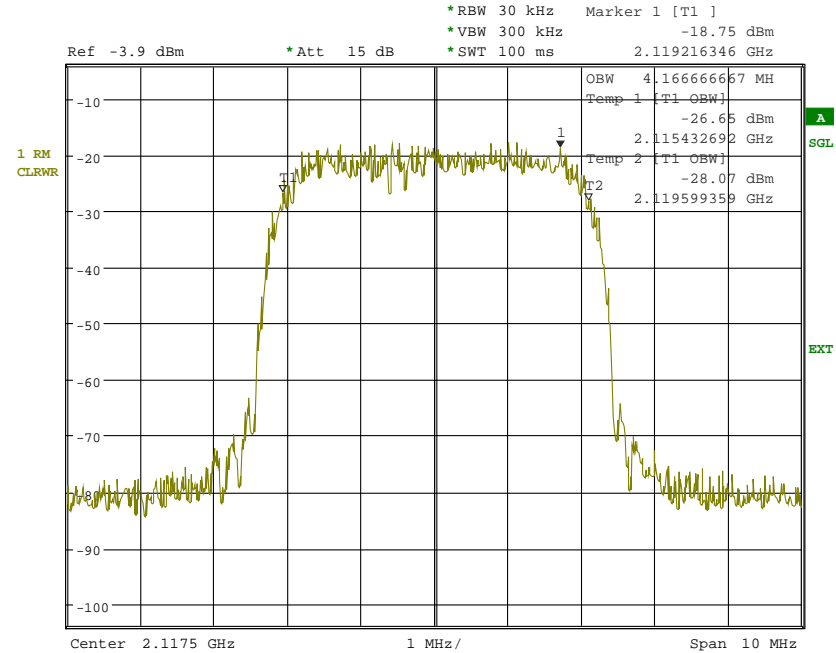

Fig. 6-5 Measurement of occupied bandwidth

Pressing the softkey activates the analyzer mode with defined settings:

SYSTEM PRESET		
After PRESET the following user-specific settings are restored, thus retaining the adaptation to the DUT:	Reference Level, Reference Level Offset Center Frequency, Frequency Offset Input Attenuation, Mixer Level All trigger settings	
OCCUPIED BANDWIDTH		
TRACE 1	DETECTOR	RMS

IEC/IEEE bus command: :CONFIGure:WCDPower:MEASurement OBANdwidth

Query of results: :CALCulate:MARKer:FUNction:POWer:RESult? OBANdwidth

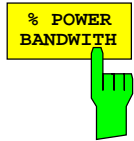

The *% POWER BANDWIDTH* softkey opens the entry of the percentage of power relative to the total power in the displayed frequency range which defines the occupied bandwidth (percentage of total power).

The valid range of values is 10% to 99.9%.

IEC/IEEE bus command:

`SENS:POW:BWID 99PCT`

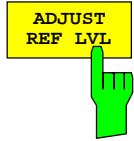

The *ADJUST REF LVL* softkey adjusts the reference level of the analyzer to the measured channel power. This ensures that the settings of the RF attenuation and the reference level are optimally adjusted to the signal level without overloading the instrument or limiting the dynamic range by an S/N ratio that is too small.

Since the measurement bandwidth for channel power measurements is significantly lower than the signal bandwidth, the signal path may be overloaded although the trace is still significantly below the reference level.

IEC/IEEE bus command:

`SENS:POW:ACH:PRES:RLEV`

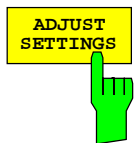

The *ADJUST SETTINGS* softkey automatically optimizes the instrument settings for the selected power measurement (see below).

All instrument settings relevant for a power measurement within a specific frequency range (channel bandwidth) are optimized for the selected channel configuration (channel bandwidth, channel spacing):

Frequency span:

The frequency span has to cover at least all channels to be considered.

When measuring the channel power, 2 x channel bandwidth is set as the span.

The setting of the span during adjacent-channel power measurement is dependent on the channel spacing and channel bandwidth of the adjacent channel ADJ, ALT1 or ALT2 with the largest distance from the transmission channel.

Resolution bandwidth  $RBW \leq 1/40$  of channel bandwidth

Video bandwidth  $VBW \geq 3 \times RBW$

Detector RMS detector

Trace math and trace averaging functions are switched off.

The reference level is not influenced by *ADJUST SETTINGS*. It can be separately adjusted with *ADJUST REF LVL*.

The adjustment is carried out only once; if necessary, the instrument settings can be changed later.

IEC/IEEE bus command:

`SENS:POW:ACH:PRES OBW`

### Signal Statistics

MEAS key

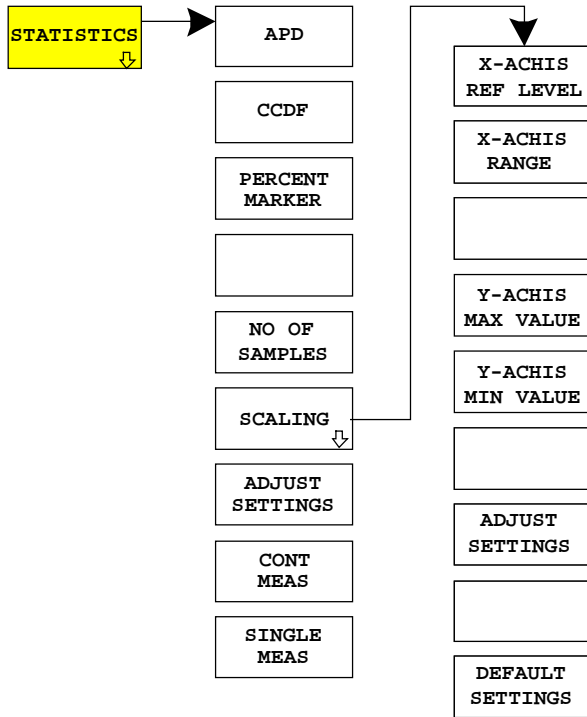

The *STATISTICS* softkey starts a measurement of the distribution function of the signal amplitudes (complementary cumulative distribution function). The measurement can be switched to amplitude power distribution (APD) by means of the menu softkeys.

For the purposes of this measurement, a signal section of user-definable length is recorded continuously in the zero span, and the distribution of the signal amplitudes is evaluated. The record length and display range of the CCDF can be set using the softkeys of the menu. The amplitude distribution is displayed logarithmically as a percentage of the amount by which a particular level is exceeded, beginning with the average value of the signal amplitudes.

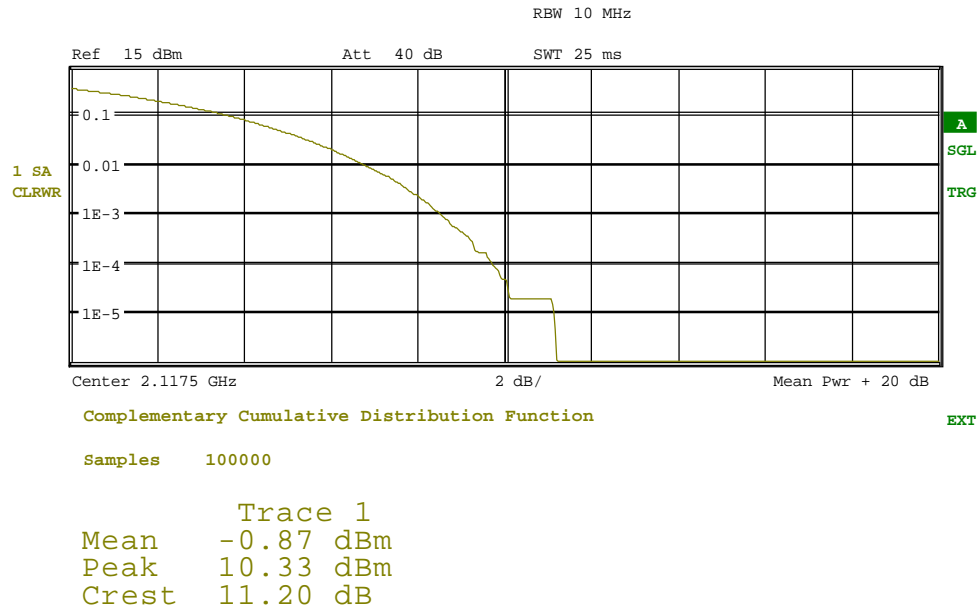

Fig. 6-6 CCDF of a 3GPP FDD signal

Pressing the softkey activates the analyzer mode with defined settings:

SYSTEM PRESET		
After PRESET the following user-specific settings are restored, thus retaining the adaptation to the DUT:		
	Reference Level, Reference Level Offset	
	Center Frequency, Frequency Offset	
	Input Attenuation, Mixer Level	
	All trigger settings	
SIGNAL STATISTIC		
TRACE1	DETECTOR	SAMPLE
BW	RES BW MANUAL	10 MHz
	VIDEO BW MANUAL	5 MHz

Starting from these settings, the FSU can be operated in all functions available in the analyzer mode, i.e. all test parameters can be adapted to the requirements of the specific measurement.

IEC/IEEE bus command: :CONFigure:WCDPower:MEASurement CCDF  
 OR  
 :CALCulate:STATistics:CCDF ON

Query of results: :CALCulate:MARKer:X?

The *APD ON/OFF* softkey switches on the amplitude probability distribution function. When the APD function is switched on, the CCDF function is switched off automatically.

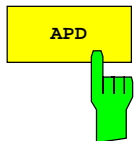

IEC/IEEE bus command: CALC:STAT:APD ON

The *CCDF ON/OFF* softkey switches on the complementary cumulative distribution function. When the CCDF function is switched on, the APD function is switched off automatically.

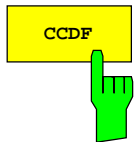

IEC/IEEE bus command: CALC:STAT:CCDF ON

If the CCDF function is active, the *PERCENT MARKER* softkey allows marker 1 to be positioned by entering a probability value. Thus, the power that is exceeded with a specified probability can be determined very easily. If marker 1 is in the switched-off state, it will be switched on automatically.



IEC/IEEE bus command: CALC:MARK:Y:PERC 0...100%

*NO OF SAMPLES* softkey sets the number of power measurements taken into account for the statistics. Please note that the overall measurement time is influenced by the number of samples selected as well as by the resolution bandwidth set up for the measurement since the resolution bandwidth directly influences the sampling rate.

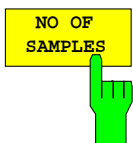

IEC/IEEE bus command: CALC:STAT:NSAM <value>

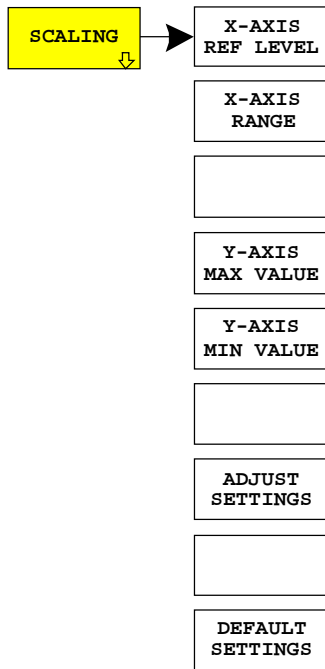

The *SCALING* softkey opens a submenu that allows the scaling parameters for both the x axis and y axis to be changed.

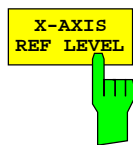

The *X-AXIS REF LEVEL* softkey changes the level settings of the instrument and sets the maximum power to be measured. The function is identical to softkey *REF LEVEL* in menu *AMPT*.

For the *APD* function, this value is mapped to the right diagram border. For the *CCDF* function, there is no direct representation of this value on the diagram because the x axis is scaled relative to the *MEAN POWER* measured.

IEC/IEEE command: `CALC:STAT:SCAL:X:RLEV <value>`

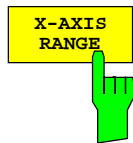

The *X-AXIS RANGE* softkey changes the level range to be covered by the statistics measurement selected.

The function is identical to softkey *RANGE LOG MANUAL* in menu *AMPT*.

IEC/IEEE command: `CALC:STAT:SCAL:X:RANG <value>`

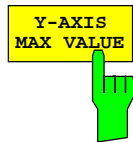

The *Y-AXIS MAX VALUE* softkey defines the upper limit of the displayed probability range.

Values on the y axis are normalized which means that the maximum value is 1.0. Since the y axis scaling has a logarithmic axis, the distance between the max and min values must be at least one decade.

IEC/IEEE command: `CALC:STAT:SCAL:Y:UPP <value>`

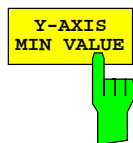

The *Y-AXIS MIN VALUE* softkey defines the lower limit of the displayed probability range.

Since the y axis scaling has a logarithmic axis, the distance between the max and min values must be at least one decade. Valid values are in the range  $0 < \text{value} < 1$ .

IEC/IEEE command: `CALC:STAT:SCAL:Y:LOW <value>`

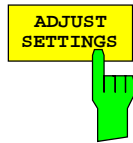

See below

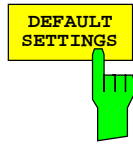

The *DEFAULT SETTINGS* softkey resets the x and y axis scales to their PRESET values.

x axis reference level: -20 dBm  
 x axis range APD: 100 dB  
 x axis range CCDF: 20 dB

y axis upper limit: 1.0  
 y axis lower limit: 1E-6

IEC/IEEE bus command: CALC:STAT:PRES



The softkey *ADJUST REF LVL* adjusts the reference level to get an optimized sensitivity. In oposite to the *ADJUST SETTINGS* softkey, only the refernce level is changed all other setting parameters are kept.

IEC--command: CALC:STAT:PRES:RLEV

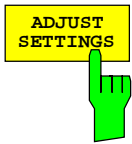

The *ADJUST SETTINGS* softkey optimizes the level settings of the FSU according to the measured peak power in order to gain maximum sensitivity of the instrument.

The level range is adjusted according to the measured difference between peak and minimum power for APD measurement and peak and mean power for CCDF measurement in order to obtain maximum power resolution.

Additionally, the probability scale is adapted to the selected number of samples.

IEC/IEEE bus command: CALC:STAT:SCAL:AUTO ONCE

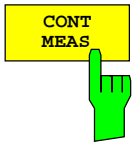

The *CONT MEAS* softkey starts collecting a new sequence of sample data and calculating the APD or CCDF curve depending on the selected measurement. The next measurement is started automatically as soon as the indicated number of samples has been reached ("CONTInuous MEASUrement").

IEC/IEEE bus command: INIT:CONT ON;  
 INIT:IMM

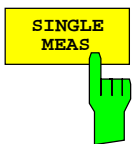

The *SINGLE MEAS* softkey starts collecting a new sequence of sample data and calculating the APD or CCDF curve depending on the selected measurement. At the beginning of the measurement, previously obtained measurement results are discarded.

IEC/IEEE bus command: INIT:CONT OFF;  
 INIT:IMM

## Code Domain Measurements on 3GPP FDD Signals

Application Firmware FS-K72/K74 provides the peak code domain error measurement and composite EVM specified by the 3GPP standard as well as the code domain power measurement and code domain error measurement of assigned and unassigned codes and a display of the composite constellation diagram of the entire signal. In addition, the symbols demodulated in a slot, their power, and the determined bits or the symbol EVM can be displayed for an active channel.

A signal section of approx. 20 ms is recorded for analysis and then searched through to find the start of a 3GPP FDD frame. If a frame start is found in the signal, CDP analysis is performed for a complete frame starting from slot 0.

Application firmware FS-K72/K74 offers two different ways of representing the code domain power measurement:

- Representation of all code channels

Option FS-K72/K74 displays the power of all occupied code channels in a bar graph. The X axis is scaled for the highest code class or the highest spreading factor (512). Code channels with a lower spreading factor occupy correspondingly more channels of the highest code class. The power of a code channel is always measured according to its symbol rate. Unused code channels are assumed to belong to the highest code class and displayed accordingly. The displayed power of an unused code channel therefore corresponds to the power of a channel with the spreading factor 512 at the respective code position.

To simplify identification, used and unused channels are displayed in different colours. Used channels are yellow and unused channels blue.

The measured power always refers to one slot. The time reference for the start of a slot is the CPICH slot. If the signal contains channels with timing offsets, the start of a slot of the channel may be different from the CPICH slot start. This leads to the power of the bar graphs normally being averaged over two adjacent slots in such cases. The power shown in the bar graphs thus does not necessarily correspond to the slot power of the channel the bar graph belongs to. If channels with a timing offset contain a power control circuit, the channel-power-versus-time display (slot spacing, see *POWER VS SLOT*) should preferably be used for power measurements (power control).

- Representation of channel power versus slots of a 3GPP FDD signal frame

In this case, the power of a selectable code channel is indicated versus a frame. The power is always measured within one slot (PCG) of the selected channel. Power control is assumed to take time at the start of the pilot symbols of the previous slots.

If code channels contain a timing offset, the start of a specific slot of the channel differs from the start of the reference channel (CPICH). Timing offsets, counted from the start of a 3GPP FDD frame, can be as long as one complete frame. The display shows the relationship: The grid of the power versus slot diagram represents the CPICH slots. The bar graphs, containing the slot power information, are plotted shifted by the timing offset. Thus, the timing offset of the channels can directly be read from the diagram.

The code domain error is displayed analogously to code domain power at a spreading factor of 512 in a bar graph diagram.

For all measurements performed in a slot of a selected channel (bits, symbols, symbol power, EVM), the actual slot spacing of the channel is taken as a basis.

The composite EVM, peak code domain error and composite constellation measurements are always referenced to the total signal.

For code domain power (CDP) measurements, the display is operated in the *SPLIT SCREEN* mode. Only those display modes showing the code domain power of all channels (*CODE PWR RELATIVE*, *CODE PWR ABSOLUTE*, *CHANNEL TABLE*) are permitted in the upper part of the screen; all other display modes are assigned to the lower part of the screen.

FS-K72/K74 expects the following synchronization channels for the code domain power measurements:

- Primary common control physical channel (PCCPCH). This channel must always be contained in the signal.
- Primary synchronization channel (PSCH).
- Secondary synchronization channel (SSCH).
- Common pilot channel (CPICH). This channel is optional. If it is not contained in the signal configuration, the firmware application FS-K72/K74 must be switched to *SYNC TYPE SCH* (see softkeys).

There are two modes for CDP analysis: *CODE CHAN AUTOSEARCH* and *CODE CHAN PREDEFINED*. FS-K72 and FS-K74 differ in both modes:

When operated in *CODE CHAN AUTOSEARCH* mode, FS-K72 performs an automatic search for active channels (DPCH) throughout the entire code domain. The search is based on the presence of known symbol sequences (pilot sequences) in the despread symbols of a channel. Channels without or with incomplete pilot sequences cannot be detected as being active in this mode. In the *AUTOSEARCH* mode, only the special channel PICH can be detected as active, even though it does not contain pilot symbols. In the *CODE CHAN PREDEFINED* mode, the user can define the active channels included in the signal via tables that can be selected and edited. For these channels, a channel search by comparison with pilot sequences is no longer performed. In this mode, special channels without pilot sequences (which should be in the code domain however) can therefore be taken into account by FS-K72 for CDP analysis.

When operated in *CODE CHAN AUTOSEARCH* mode, FS-K74 performs an automatic search for channels throughout the entire code domain. This search is not based on the presence of any known symbol sequences. Therefore, with FS-K74, channels of High Speed Data Packet Access (HSDPA) that do not contain pilot sequences can be detected as well. Additionally, the possibility of different modulation types within the channels is taken into account. Thus, channels with a modulation type differing from the usual QPSK of DPCH are properly measured as well. In mode *CODE CHAN PREDEFINED*, the channels contained in the signal are considered as predefined analogously to FS-K72. Only the modulation type of each channel will be measured by the firmware application.



## Display Mode – RESULTS hotkey

### RESULTS hotkey

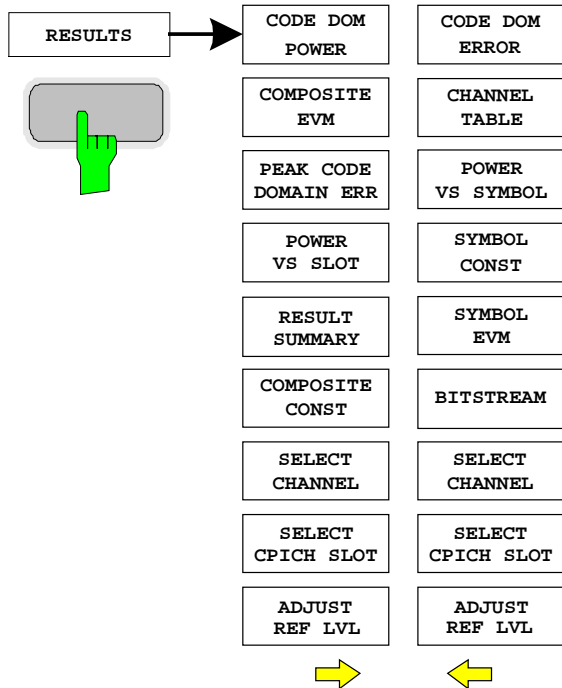

The *RESULTS* hotkey opens a submenu for setting the display mode. The main menu contains the most important display modes as well as the measurements specified by the 3GPP standard for fast access, whereas the side menu contains more detailed display modes.

The following display modes are available:

#### CODE DOM POWER

Code domain power (screen A).

#### COMPOSITE EVM

Square difference between test signal and ideal reference signal at the chip level (screen B).

#### PEAK CODE DOMAIN ERR

Projection of the error between the test signal and the ideal reference signal onto the spreading factor of code class 8 and subsequent averaging using the symbols of each slot of the difference signal. The maximum value of all codes is displayed versus the CPICH slot number (screen B).

#### POWER VS SLOT

Power of the selected channel versus all slots of a 3GPP FDD signal frame (screen B).

#### RESULT SUMMARY

Tabular result display (screen B).

#### COMPOSITE CONST

Constellation diagram of descrambled chips (screen B).

#### CODE DOM ERROR

Projection of the error power between the test signal and the ideal reference signal onto the spreading factor of the highest code class (CC = 9) and subsequent averaging using the symbols of the selected channel slot of the difference signal. The error power is displayed versus all codes of code class 9 (screen A).

#### CHANNEL TABLE

Display of channel occupancy table (screen A).

#### POWER VS SYMBOL

Display of symbol power at the selected slot (screen B).

#### SYMBOL CONST

Display of constellation diagram (screen B).

#### SYMBOL EVM

Display of error vector magnitude diagram (screen B).

#### BITSTREAM

Display of the determined bits (screen B)

#### SELECT CHANNEL

Marking of channel for the following display modes  
*POWER VS SLOT,*

RESULT SUMMARY  
 POWER VS SYMBOL,  
 SYMBOL CONST,  
 SYMBOL EVM,  
 BITSTREAM.

SELECT CPICH SLOT Selection of CPICH SLOTS in a frame for display of

CODE DOMAIN POWER  
 PEAK CODE DOMAIN ERROR  
 RESULT SUMMARY  
 COMPOSITE CONS,  
 CODE DOMAIN ERROR POWER  
 CHANNEL TABLE  
 POWER VS SYMBOL  
 SYMBOL CONST  
 SYMBOL EVM  
 BITSTREAM

ADJUST REF LVL

Optimum adaptation of the reference level in the instrument to the signal level.

The most important measurement settings which form the basis of the display modes are summarized above the diagram:

Code Power Relative		SR 30 ksps
		Chan Code 69
CF 2.11 GHz	CPICH Slot 4	Chan Slot 11

Fig. 6-7 Indication of measurement parameters

The different elements are:

1st column:

Code Power Relative: Name of selected display mode  
 {empty}  
 CF 2.11 GHz: Center frequency of signal

2nd column:

{empty}  
 {empty}  
 CPICH Slot 4: CPICH slot number (value of SELECT CPICH SLOT softkey)

3rd column:

SR 30 ksps: Symbol rate of selected channel  
 Chan Code 69: Spreading code of selected channel  
 Chan Slot 11: Slot number of selected channel

**Note:** For the peak code domain error display mode, the indication of the symbol rate is replaced by the indication of the spreading factor onto which the error is projected (see PEAK CODE DOMAIN ERR softkey)

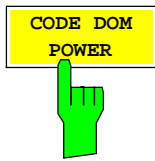

The *CODE DOM POWER* softkey selects the code domain power display mode.

The scaling of the displayed result depends on the softkey *SETTINGS* → *CODE PWR ABS / REL*. In the case of a relative display (*REL*), the power of the channels is referenced to a reference power of the selected slot. The values are specified in dB. In the case of an absolute display (*ABS*), the absolute power values are specified in dBm.

In default mode, the power of the channels is referenced to the *CPICH* power (*SETTINGS* → *POWER REF* → *CPICH*). This power reference was selected since the total power may vary depending on the slot due to the capability to control the power in the different code channels. In contrast to the variable total power, the power of the *CPICH* is the same in all slots so that it can form the constant reference for the display. The reference can be switched to total power by selecting *SETTINGS* → *POWER REF* → *TOT*.

The measurement interval for determining the power of the channels is a slot in the *CPICH* (corresponding to a timing offset of 0 chips referenced to the beginning of the signal frame).

The powers of the active channels and of the unassigned codes are shown in different colours:

- yellow: active channels
- blue: unassigned codes

If the analyzer is equipped with FS-K72 and operated in *CODE CHAN AUTOSEARCH* (automatic channel search mode) mode, a data channel is considered to be active if the pilot symbols as specified by the 3GPP standard are found at the end of each slot. In this mode, channels without pilot symbols are therefore not recognized by FS-K72. An exception to this rule is seen in the special channels *PICH* and *SCCPCH*, which can be recognized as active in the automatic search mode although they do not contain pilot symbols. In addition, the channel must exceed a minimum power (see *INACT CHAN THRESHOLD* softkey).

In *CODE CHAN PREDEFINED* mode, each data channel that is included in the user defined channel table is considered to be active.

If the analyzer is additionally equipped with FS-K74, all channels that meet special quality criteria are recognized as active. The detection of channels does not depend on pilot sequences or other previously known symbol sequences in FS-K74. An active channel merely has to exceed a minimum power (see *INACT CHAN THRESHOLD* softkey).

In the case of an analyzer equipped with FS-K72, the effect of missing or incomplete pilot symbols in a data channel can be shown in the *CDP* diagram by operating in analyzer mode *CODE CHANNEL AUTOSEARCH*. At the points of the *CDP* diagram where the channel should appear due to its spreading code, a power value higher than the noise occurs. The associated bars, however, are displayed in blue (black in the figure). In such a case, the channel should be checked for its pilot symbols. In *CODE CHANNEL PREDEFINED* mode, the channel should be included in the user-defined channel table.

If the analyzer is additionally equipped with FS-K74, channels without pilot sequences are also recognized as active if they meet special quality criteria.

The following figures show how the CDP is displayed when all active channels contained in the signal have been found (analyzer equipped with FS-K72).

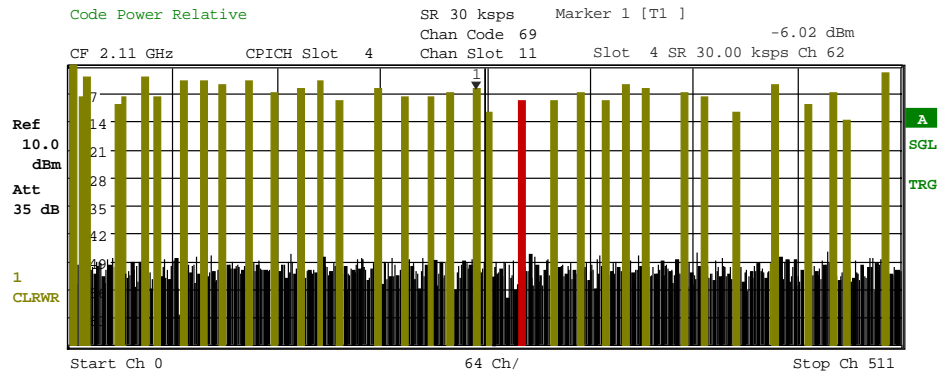

Fig. 6-8 CDP diagram with all channels recognized as active

In the CDP diagram, the effect of missing or incomplete pilot symbols in a data channel can be shown in analyzer mode *CODE CHANNEL AUTOSEARCH*. At the points of the CDP diagram where the channel should appear due to its spreading code, a power value higher than the noise occurs. The associated bars, however, are displayed in blue. In such a case, the channel should be checked for its pilot symbols. In *CODE CHANNEL PREDEFINED* mode, the channel should be included in the user-defined channel table.

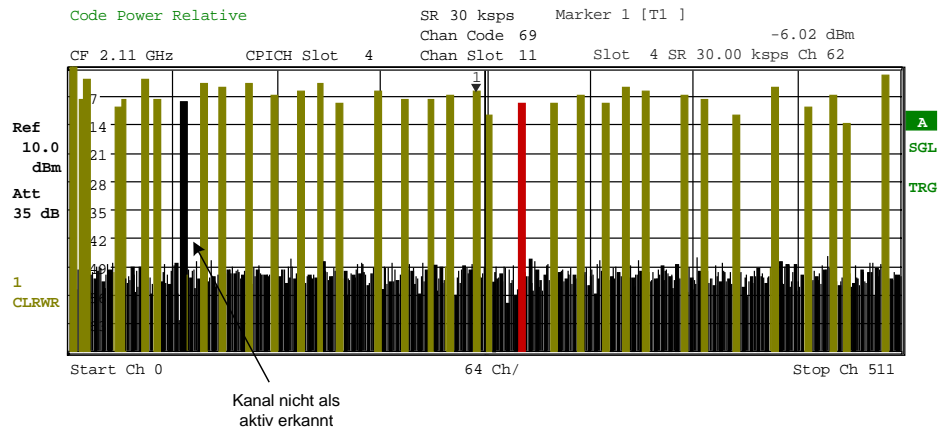

Fig. 6-9 CDP diagram with one of the channels recognized as inactive

If some of the DPCH contains incorrect pilot symbols, these channels are marked with the color magenta, and a message "INCORRECT PILOT" is displayed. The incorrect pilot symbol can be determined by using the POWER VS SLOT and the BITSTREAM display.

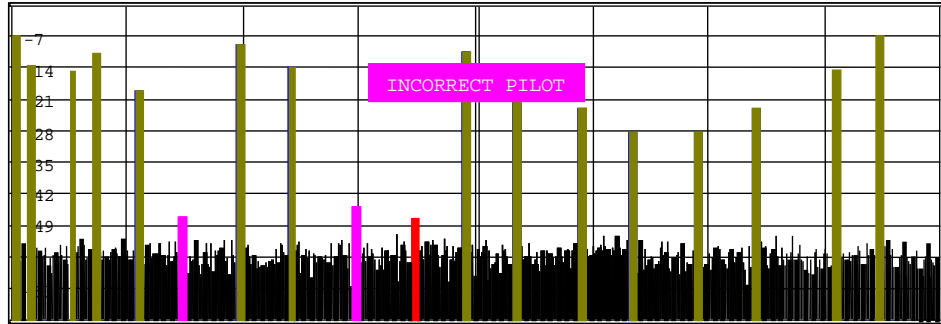

Fig. 6-10 CDP diagram with some channels including an incorrect pilot sequence.

In the case of an analyzer equipped with FS-K74, channels without pilot symbols, e.g. channels of type HS-PDSCH, are recognized as active. The following figure shows test model 5 with eight HS-PDSCH channels and 30 DPCH channels.

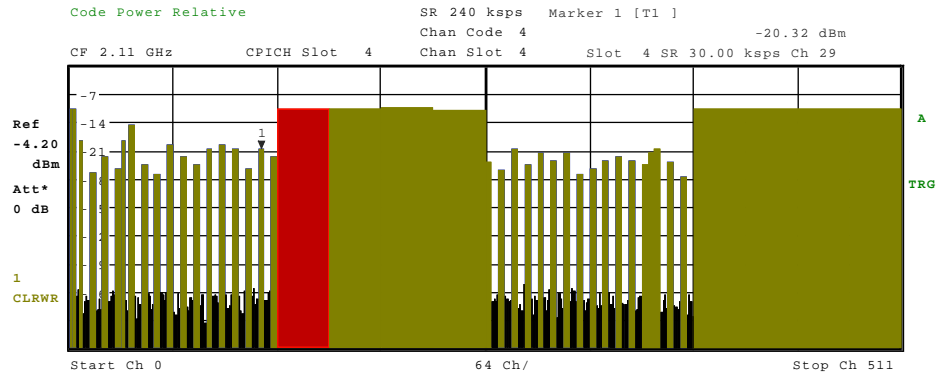

Fig. 6-11 CDP diagram for test model 5

By entering a channel number (see *SELECT CHANNEL* softkey), it is possible to mark a channel for more detailed display modes. The marked channel is shown in red. The entire channel is marked if it is an assigned channel; only the entered code is marked in the case of an unassigned code. Selecting other display modes (e.g. *SYMBOL CONSTELLATION*) for unassigned codes is possible but irrelevant since the results are not valid.

IEC/IEEE bus command:     :CALCulate<1>:FEED "XPOW:CDP"  
                               :CALCulate<1>:FEED "XPOW:CDP:ABS"  
                               :CALCulate<1>:FEED "XPOW:CDP:RAT"



The *COMPOSITE EVM* softkey selects the composite EVM (modulation accuracy) display mode according to the 3GPP specification.

During the composite EVM measurement, the square root of the squared errors between the real and imaginary components of the test signal and an ideal reference signal (EVM referenced to the total signal) is determined. Thus, composite EVM is a measurement of the composite signal.

The measurement result consists of one composite EVM measurement value per slot. In this case, the measurement interval is the slot spacing of the CPICH (timing offset of 0 chips referenced to the beginning of the frame).

Only the channels recognized as active are used to generate the ideal reference signal. If an assigned channel is not recognized as active since pilot symbols are missing or incomplete, the difference between the measurement and reference signal and the composite EVM is very high (see figures).

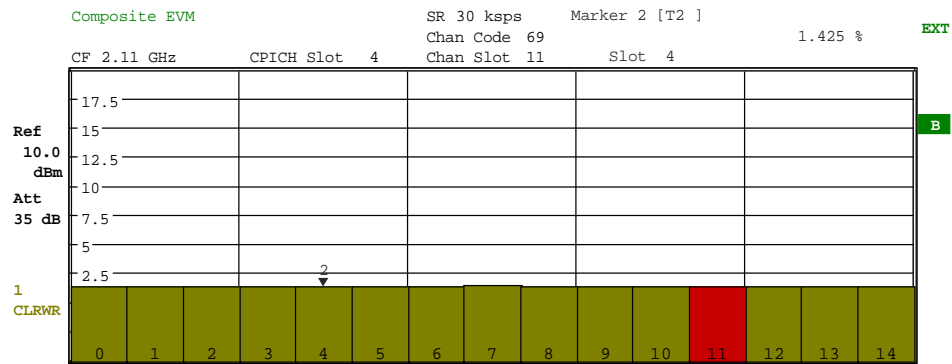

Fig. 6-12 Composite EVM - all channels are recognized as active

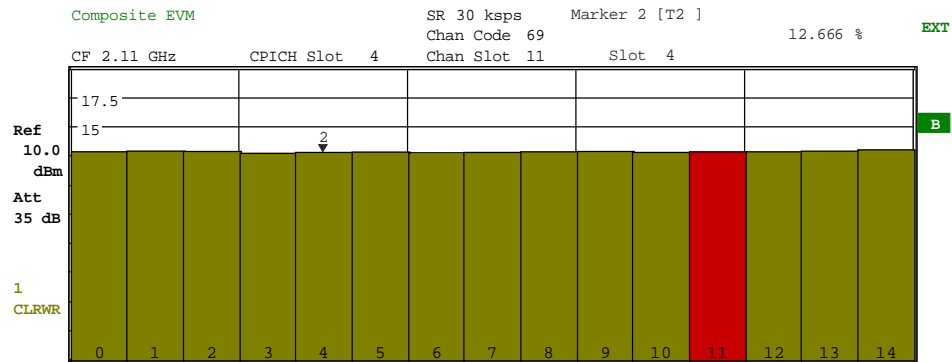
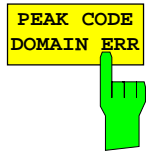

Fig. 6-13 Composite EVM - one channel is recognized as inactive

IEC/IEEE bus command: :CALCulate2:FEED "XTIM:CDP:MACCuracy"



The *PEAK CODE DOMAIN ERR* softkey selects the peak code domain error display mode.

In line with the 3GPP specifications, the error between the measurement signal and the ideal reference signal is projected onto the various spreading factors. The desired spreading factor is selected by a table which is opened when the softkey is activated.

The result consists of one numerical value per slot for the peak code domain error value. The measurement interval is the slot spacing of the CPICH (timing offset of 0 chips referenced to the beginning of the frame).

Only the channels recognized as active are used to generate the ideal reference signal for the peak code domain error. If an assigned channel is not recognized as active since pilot symbols are missing or incomplete, the difference between the measurement and reference signal is very high. FS-K72/K74 consequently indicates a peak code domain error that is too high (see figures).

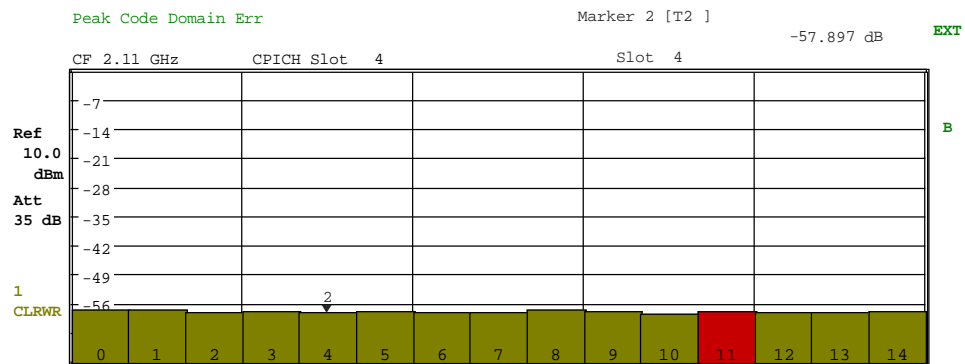

Fig. 6-14 Peak domain error - all channels are recognized as active

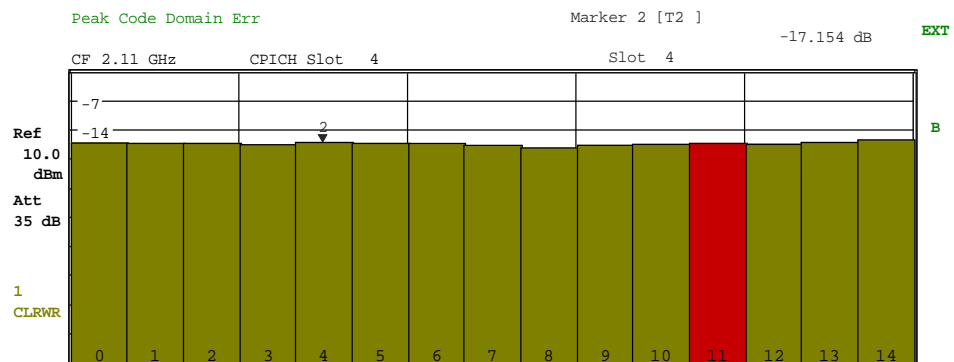
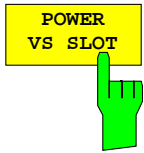

Fig. 6-15 Peak domain error - one channel is not recognized as active

IEC/IEEE bus command: :CALCulate2:FEED "XTIM:CDP:ERR:PCDomain"



The *POWER VS SLOT* softkey selects the indication of the power of the selected code channel depending on the slot number. The power of the selected channel (marked red in the CDP diagram) is displayed versus all slots of a frame of the 3GPP FDD signal.

Fifteen (15) slots of a WCDMA frame are displayed. When the power is averaged versus the symbols of a slot, the time of the power control is assumed to be at the beginning of the pilot symbols of the previous slot (power group).

The following has to be taken into account: Due to the timing offset (up to one frame) admissible for the channels, the beginning of slot 0 of the selected channel is shifted with reference to the start of the frame (reference: CPICH slot 0). The timing offset therefore also has to be applied to the power-versus-slot display. To show the correlation between timing offset and CDP analysis in the diagram, the X axis reflects the slot spacing of the channel as well as of the CPICH.

- The grid of the power-versus-slot display reflects the spacing of the CPICH slots. The slots are always labelled at the grid line where the slot in question begins (top labelling of x axis in diagram). The first CPICH slot is always slot 0. The grid and the labels of the grid lines thus do not change.
- Shifted by the timing offset, the power versus channel slots are entered in a bar graph. The slot numbers of the channel are labelled within the bar associated with the slot. The position of the bars in relation to the grid and the slot numbering within the bar vary as a function of the timing offset of the channel selected.

The following figure shows a channel with power control (power decrease of 2 dB for each slot). Since the channel has a timing offset (22528 chips), the display does not start with slot 0 of the channel but is shifted by the timing offset. The slot that is marked red is the selected CPICH slot. As shown in the display, the CPICH slot covers two adjacent slots:

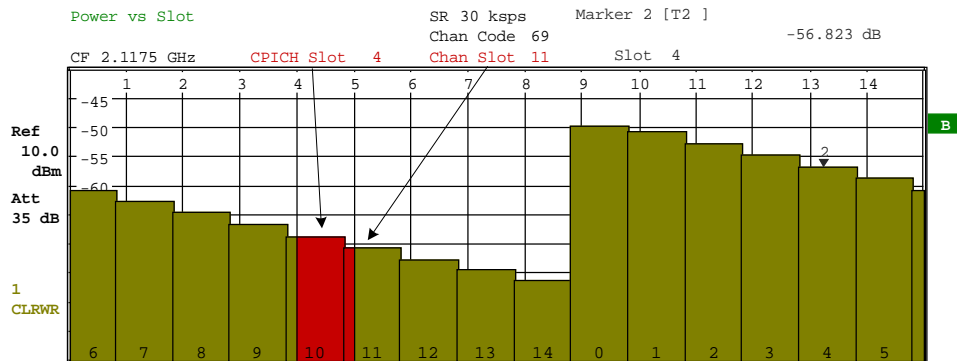

Fig. 6-16 Power versus slot for a channel with power control (timing offset 22528 chips)

It is not only possible to select a code channel in the CDP diagram, but also to mark a slot in the power-versus-slot diagram. Marking is done by entering the CPICH slot number (see *SELECT CPICH SLOT* softkey) and the selected CPICH slot is marked in red. If the channel displayed has a timing offset with respect to the CPICH, the marked slot is usually shifted against the slot grid of the channel, i.e. the red marking of a slot covers two of the bars below. The timing offset can be directly read from the shifting. For more detailed displays, the slot of the channel is selected that starts within the red slot marking (see *CHAN SLOT* entry in the function panels above the diagrams in the figures).

Modifying a slot number has the following effects:

- The CDP diagram in the upper half of the display is updated relative to the entered CPICH slot number.
- Starting from the CPICH slot, all dependent results are calculated for the



actual slot of the selected channel. The relevant graphics are updated. The slot of the channel that starts within the CPICH slot displayed in red is considered marked.

If one of the channel slots of a DPCH contains incorrect pilot symbols, these symbols are indicated in the color magenta (figure below). By selecting this slot by *SELECT CPICH Slot*, the incorrect pilot symbol can be evaluated in the "Bitstream" display.

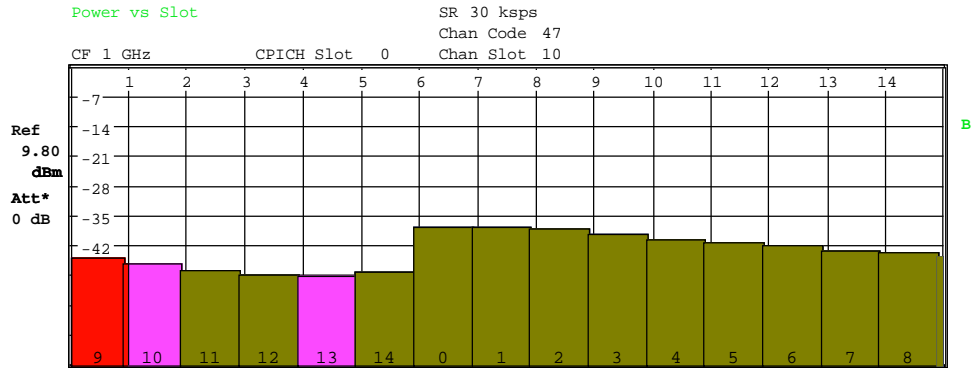

Fig. 6-17 Power versus slot for a channel with incorrect pilot symbols at channel slots 10 and 13.

IEC/IEEE bus command: :CALCulate2:FEED "XTIM:CDP:PVSLOT "



The *RESULT SUMMARY* softkey selects the numeric display of all results. The display is subdivided as follows:

GLOBAL RESULTS		Carrier Freq Error	
Total Power	-14.79 dBm	Carrier Freq Error	1.63 Hz
Chip Rate Error	-0.01 ppm	Trigger to Frame	1.405356 μs
IQ Offset	0.49 %	IQ Imbalance	0.07 %
Composite EVM	1.90 %	Pk CDE (15 ksps)	-55.70 dB
CPICH Slot No	0	No of Active Chan	44
CHANNEL RESULTS		Timing Offset	
Symbol Rate	240.00 ksps	Timing Offset	0 Chips
Channel Code	4	Channel Slot No	0
No of Pilot Bits	0	Modulation Type	16QAM
Channel Power Rel	-10.95 dB	Channel Power Abs	-25.74 dBm
Symbol EVM	5.16 % rms	Symbol EVM	8.65 % Pk

Fig. 6-18 Result summary

The upper part contains the results for the total signal:

**Total Power:** Outputs the total signal power (average power of total evaluated 3GPP FDD frame).

**Carrier Freq Error:** Outputs the frequency error relative to the center frequency of the analyzer. The absolute frequency error is the sum of the analyzer and DUT frequency error. The specified value is averaged via one slot; the frequency offset of the slot selected under SELECT CPICH SLOT applies. The maximum frequency error that can be compensated is specified in the table below as a function of the sync mode. Transmitter and receiver should be synchronized as far as possible (see chapter 2, Getting Started).

Table 6-1: Maximum compensated frequency error

SYNC TYPE	ANTENNA DIV	Max. Freq. Offset
CPICH	X	5.0 kHz
SCH	OFF	1.6 kHz
SCH	ANT 1	330 Hz
SCH	ANT 2	330 Hz

**Chip Rate Error:** Outputs the chip rate error in ppm. As a result of a high chip rate error, symbol errors arise and the CDP measurement is possibly not synchronized to the 3GPP FDD signal. The result is valid even if synchronization of the analyzer and signal failed.

**Trigger to Frame:** This result outputs the time difference between the beginning of the recorded signal section to the start of the analyzed 3GPP FDD frame. In the case of triggered data collection, this difference is identical with the time difference of frame trigger (+ trigger offset) – frame start. If synchronization of the analyzer and W-CDMA signal fails, the value of Trigger to Frame is not significant.

**IQ Offset:** DC offset of signals in %

**IQ Imbalance:** I/Q imbalance of signal in %

**Composite EVM:** The composite EVM is the difference between the test signal and the ideal reference signal (see *COMPOSITE EVM* softkey).

- The composite EVM value for the selected slot is specified in the *RESULT SUMMARY*.
- Pk CDE:** The *PEAK CODE DOMAIN ERROR* measurement specifies a projection of the difference between the test signal and the ideal reference signal onto the selected spreading factor (see *PEAK CODE DOMAIN ERR* softkey). The Pk CDE value for the selected slot is indicated in the *RESULT SUMMARY*. The spreading factor onto which projection is made is shown beneath the measurement result.
- CPICH Slot No:** Outputs the number of the CPICH slot at which the measurement is performed (see *SELECT CPICH SLOT* softkey).
- No of Active Chan:**  
Indicates the number of active channels detected in the signal. Both the detected data channels and the control channels are considered active channels.
- The results of measurements on the selected channel (red in the diagram) are displayed in the lower part of the *RESULT SUMMARY*.
- Symbol Rate:** Symbol rate at which the channel is transmitted.
- Timing Offset:** Offset between the start of the first slot in the channel and the start of the analyzed 3GPP FDD frame.
- Modulation Type :** Modulation type of an HSDPA channel. High speed physical data channels can be modulated with QPSK or 16QAM modulation. The modulation type is measured only if the HSDPA option (K74) is installed.
- Channel Code:** Number of the spreading code of the selected channel.
- Channel Slot No:** The channel slot number is obtained by combining the value of the *SELECT CPICH SLOT* softkey and the channel's timing offset.
- No of Pilot Bits:** Number of pilot bits of the selected channel.
- Chan Pow rel. / abs.:**  
Channel power, relative (referenced to CPICH or total signal power) and absolute.
- Symbol EVM Pk / rms:**  
Peak or average of the results of the error vector magnitude measurement (see *SYMBOL EVM* softkey). The measurement provides information on the EVM of the channel (marked red) in the CDP diagram in the slot (marked red) of the power-versus-slot diagram at the symbol level.
- IEC/IEEE bus command:**
- ```
:CALCulate2:FEED "XTIM:CDP:ERR:SUMM"
:CALCulate<1|2>:MARKer<1>:FUNctioN:WCDPower:RESult?
PTOTAL | FERRor | TFRame | TOFFset | MACCuracy |
PCDError | EVMRms | EVMPeak | CERRor | CSLot |
SRATE | CHANnel | CDPabsolute | CDPRelative |
IQOFFset | IQIMbalance | MTYPE
```

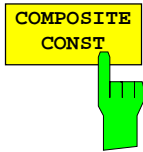

COMPOSITE CONSTELLATION:

Display of constellation diagram for the chips of all channels. The displayed constellation points are normalized with the square root of the total power.

Value range:

$$Z = [0...2.5] \cdot (\pm 1 \pm j)$$

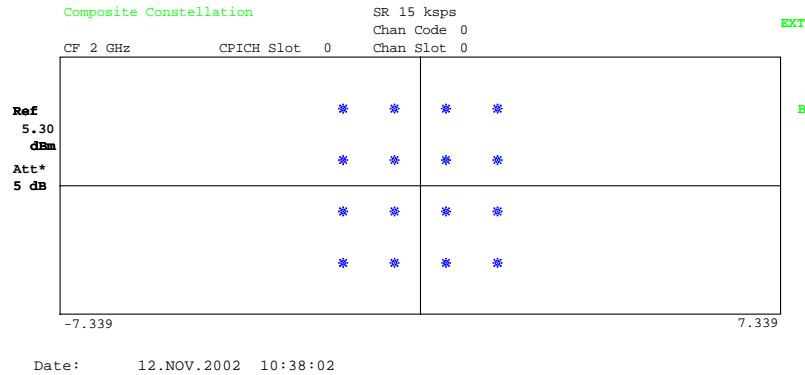
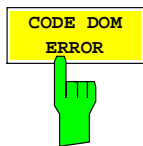

Fig. 6-19 Composite constellation diagram

IEC/IEEE bus command: :CALCulate<1>:FEED  
"XTIM:CDP:COMP:CONStellation"

Query of result: :TRACe<1>:DATa? TRACe2

Output: List of I/Q values of all chips per slot  
Format: Re<sub>1</sub>,Im<sub>1</sub>,Re<sub>2</sub>,Im<sub>2</sub>,...,Re<sub>2560</sub>,Im<sub>2560</sub>  
Unit: [1]  
Quantity: 2560



The *CODE DOM ERROR* softkey displays the code domain error power (CDEP) versus the code channels of code class 9. The error power is always referenced to the total power.

The code domain error power (CDEP) is calculated by subtracting the received chips (chip<sub>rec</sub>) from a chip-stream of a generated reference signal (chip<sub>ref</sub>). This difference or error signal is despread to all (512) code channels of CC9 (Dspr<sub>n</sub>). The average power of the error signal of each CC9 code channel is relative to the total power of the selected slot. The measurement interval for determining the CDEP of the channels is a slot in the CPICH (corresponding to a timing offset of 0 chips referenced to the beginning of the signal frame).

The powers of the active channels and of the unassigned codes are shown in different colours:

- yellow: active channels
- blue: unassigned codes

The CDEP is calculated for each channel of code class 9 (CC9). In the case of active or inactive channels, only the color is changed. In contrast to the code domain power measurement, the code domain error power of active channels is not subsumed to a common value.

By entering a channel number (see *SELECT CHANNEL* softkey), it is possible to mark a channel for more detailed display modes. The marked channel is shown in red. Only the first CC9 code channel of an assigned channel is marked.

In the case of a correct WCDMA signal, the code domain error power (CDEP) of all CC 9 channels should be equal. The maximum error power of a channel should not be much higher than the average noise.

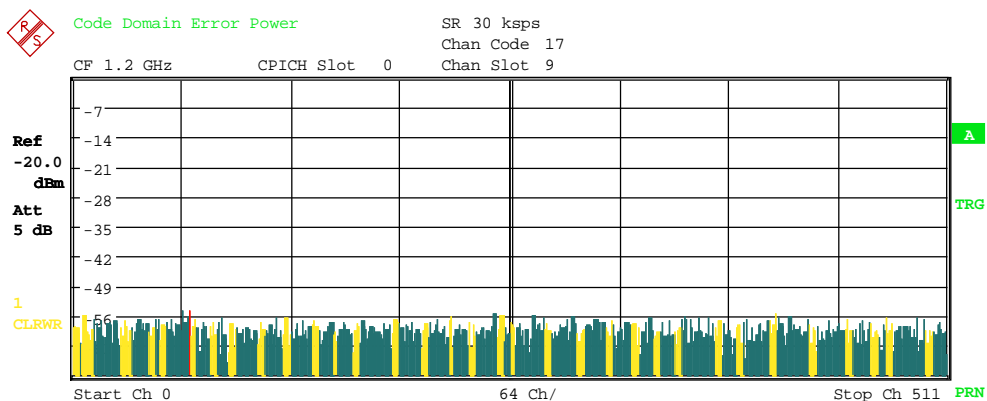

Fig. 6-20 Code domain error display of a correct WCDMA signal

In the case of an incorrect WCDMA signal, the code domain error power (CDEP) of the affected channel is much higher than the average error power. It can be determined at which code number the error occurs.

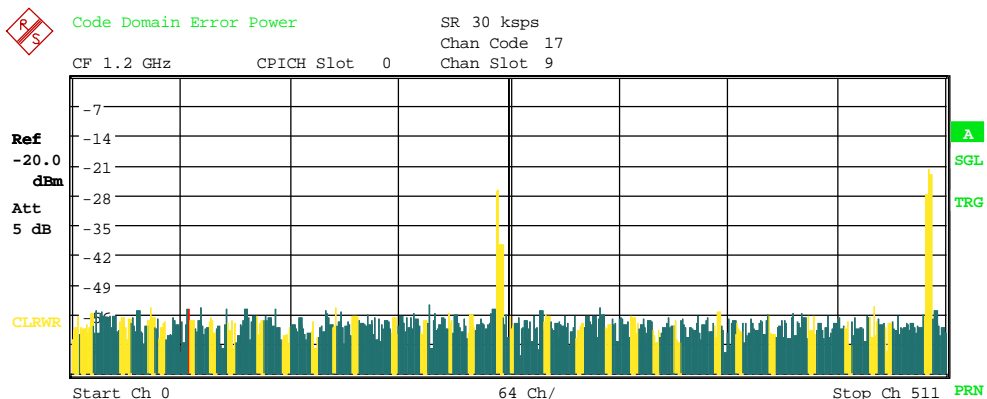

Fig. 6-21 Code domain error display of an incorrect WCDMA signal

IEC/IEEE bus command: :CALCulate<1>:FEED "XPOWER:CDEP"

Query of result: :TRACe<1>:DATA? TRACe1

Output: CDEP list of each CC9 channel

Format: <code class><sub>1</sub>, <code number><sub>1</sub>, <CDEP><sub>1</sub>, <channel flag><sub>1</sub>,  
<code class><sub>2</sub>, <code number><sub>2</sub>, <CDEP><sub>2</sub>, <channel flag><sub>2</sub>,  
,.....,  
<code class><sub>512</sub>, <code number><sub>512</sub>, <CDEP><sub>512</sub>, <channel flag><sub>512</sub>

Unit: < [1] >, < [1] >, < [dB] >, < [1] >

Range: < 9 >, < 0...511 >, < -∞ ... ∞ >, < 0 ; 1 ; 3 >

Quantity: 512

Code class: Highest code class of a WCDMA signal is always set to 9 (CC9)

Code number: Code number of the evaluated CC9 channel

CDEP: Code domain error power value of the CC9 channel

Channel flag: Denotes whether the CC9 channel belongs to an assigned code channel or not:

|        |      |     |                                                                                          |
|--------|------|-----|------------------------------------------------------------------------------------------|
| Range: | 0b00 | 0d0 | - CC9 is inactive                                                                        |
|        | 0b01 | 0d1 | - CC9 channel belongs to an active code channel                                          |
|        | 0b11 | 0d3 | - CC9 channel belongs to an active code channel with incorrect transmitted pilot symbols |

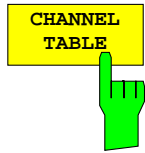

The *CHANNEL TABLE* softkey selects the display of the channel assignment table. The channel assignment table can contain a maximum of 512 entries, corresponding to the 512 codes that can be assigned within the class of spreading factor 512.

The upper part of the table indicates the channels that have to be present in the signal to be analyzed:

**CPICH:** The **C**ommon **P**ilot **C**hannel is used to synchronize the signal in the case of CPICH synchronization. It is expected at code class 8 and code number 0.

**PSCH:** The **P**rietary **S**ynchronization **C**hannel is used to synchronize the signal in the case of SCH synchronization. It is a nonorthogonal channel. Only the power of this channel is determined.

**SSCH:** The **S**econdary **S**ynchronization **C**hannel is a nonorthogonal channel. Only the power of this channel is determined.

**PCCPCH:** The **P**rietary **C**ommon **C**ontrol **P**hysical **C**hannel is also used to synchronize the signal in the case of SCH synchronization. It is expected at code class 8 and code number 1.

**SCCPCH:** The **S**econdary **C**ommon **C**ontrol **P**hysical **C**hannel is a QPSK-modulated channel without any pilot symbols. In the 3GPP test models, this channel can be found in code class 8 and code number 3. However, the code class and code number need not to be fixed and can vary. For this reason, the following rules are used to indicate the SCCPCH.

**K72:** - Only one QPSK-modulated channel without pilot symbols is detected and displayed as the SCCPCH. Any further QPSK-modulated channels without pilot symbols are not detected as active channels.

- If the signal contains more than one channel without pilot symbols, the channel that is received in the highest code class and with the lowest code number is displayed as the SCCPCH. It is expected that only one channel of this type is included in the received signal. According to this assumption, this channel is probably the SCCPCH

**K74:** - All QPSK-modulated channels without pilot symbols are detected. If one of these channels is received at code class 8 and code number 3, it is displayed as the SCCPCH. Any other QPSK-modulated channels without pilot symbols and a code class higher than or equal to 7 are marked with the channel type CHAN. All further QPSK-modulated channels without pilot symbols and a code class lower than 7 are marked with channel type HSPDSCH.

**PICH:** The **P**aging **I**ndication **C**hannel is expected at code class 8 and code number 16.

The lower part of the table indicates the data channels contained in the signal. A data channel is any channel that does not have a predefined channel number and symbol rate. There are different types of data channels, which can be indicated by the entry in the column "Chan Type":

**DPCH:** The **D**edicated **P**hysical **C**hannel is a data channel that contains pilot symbols. The displayed channel type is DPCH.

Chan Type: DPCH

Status: inactive channel is not active  
 active channel is active and all pilot symbols are correct  
 pilotf channel is active but it contains incorrect pilot symbols

**HS-PDSCH** The **H**igh **S**peed **P**hysical **D**ownlink **S**hared **C**hannel (HSDPA) does not contain any pilot symbols. It is a channel type that is expected in code classes lower than 7. The modulation type of these channels

can be varied depending on the selected slot.

Chan Type: HSPDSCH-QPSK\_ QPSK-modulated slot of an HS-PDSCH channel  
 HSPDSCH-16QAM\_ 16QAM-modulated slot of an HS-PDSCH channel  
 HSPDSCH-NONE\_ slot without power of an HS-PDSCH channel

Status: inactive channel is not active  
 active channel is active

HS-SSCH The **H**igh **S**peed **S**hared **C**ontrol **C**hannel (HSDPA) does not contain any pilot symbols. It is a channel type that is expected in code classes equal to or higher than 7. The modulation type should always be QPSK. The channel does not contain any pilot symbols.

Chan Type: CHAN\_ QPSK-modulated channel without any pilot symbols

Status: inactive channel is not active  
 active channel is active

If the analyzer is equipped with FS-K74, the channels of HSDPA will be found among the data channels. If the type of a channel can be fully recognized, as for example with a DPCH (based on pilot sequences) or HS-PDSCH (based on modulation type), the type will be entered in the field *TYPE*. All other channels without pilot symbols are of type CHAN. The channels are in descending order according to symbol rates and, within a symbol rate, in ascending order according to the channel numbers. Therefore, the unassigned codes are always to be found at the end of the table.

If the modulation type for a channel can vary, the measured value of the modulation type will be appended to the type of the channel.

The following figures show the channel table for two cases:

Channel Table SR 30 kbps  
 Chan Code 69  
 CF 2.11 GHz CPICH Slot 4 Chan Slot 11

| Channel Table |        |           |       |        |      |        |         |         |        |     |
|---------------|--------|-----------|-------|--------|------|--------|---------|---------|--------|-----|
|               | Type   | Symb Rate | Chan# | Status | TFCI | PilotL | Pwr Abs | Pwr Rel | T Offs |     |
| Ref           | CPICH  | 15.0 kbps | 0     | active | ---  | ---    | -10.70  | 0.00    | ---    | A   |
| 10.0 dBm      | PSCH   | -. kbps   | ---   | active | ---  | ---    | -13.69  | -2.99   | ---    | SGL |
|               | SSCH   | -. kbps   | ---   | active | ---  | ---    | -13.72  | -3.02   | ---    |     |
| Att           | PCCPCH | 15.0 kbps | 1     | active | ---  | ---    | -10.70  | -0.00   | ---    | TRG |
| 35 dB         | SCCPCH | 15.0 kbps | 3     | active | ON   | 8      | -18.71  | -8.01   | 0      |     |
|               | PICH   | 15.0 kbps | 16    | active | ---  | ---    | -18.67  | -7.97   | 30720  |     |
|               | DPCH   | 30.0 kbps | 69    | active | ON   | 8      | -19.68  | -8.98   | 22528  |     |
| 1             | DPCH   | 30.0 kbps | 74    | active | ON   | 8      | -19.72  | -9.02   | 16640  |     |
| CLRWR         | DPCH   | 30.0 kbps | 78    | active | ON   | 8      | -17.71  | -7.01   | 7680   |     |
|               | DPCH   | 30.0 kbps | 82    | active | ON   | 8      | -19.71  | -9.01   | 9472   |     |

Fig. 6-22 Channel table of FS-K72 and measuring test model 1.

Channel Table

SR 240 kbps  
Chan Code 4  
Chan Slot 0

CF 2.11 GHz CPICH Slot 0

|           | Chan Type     | Symb Rate [kps] | Chan# | Status | TFCI | PilotL [Bits] | Pwr Abs [dBm] | Pwr Rel [dB] | T Offs [Chips] |     |
|-----------|---------------|-----------------|-------|--------|------|---------------|---------------|--------------|----------------|-----|
| Ref       | CPICH         | 15.0            | 0     | active | ---  | ---           | -25.78        | -10.96       | ---            | λ   |
| -4.20 dBm | PSCH          | --              | ---   | active | ---  | ---           | -29.03        | -14.21       | ---            |     |
|           | SSCH          | --              | ---   | active | ---  | ---           | -28.51        | -13.69       | ---            | TRG |
| Att* 0 dB | PCCPCH        | 15.0            | 1     | active | ---  | ---           | -25.78        | -10.96       | ---            |     |
|           | SCCPCH        | --              | ---   | inactv | ---  | ---           | ---           | ---          | ---            |     |
|           | PICH          | 15.0            | 16    | active | ---  | ---           | -33.82        | -18.99       | 30720          |     |
|           | HSPDSCH-16QAM | 240.0           | 4     | active | ---  | ---           | -25.78        | -10.95       | 0              |     |
|           | HSPDSCH-16QAM | 240.0           | 5     | active | ---  | ---           | -25.94        | -11.12       | 0              |     |
|           | HSPDSCH-16QAM | 240.0           | 6     | active | ---  | ---           | -25.63        | -10.81       | 0              |     |
|           | HSPDSCH-16QAM | 240.0           | 7     | active | ---  | ---           | -26.01        | -11.19       | 0              |     |

Fig. 6-23 Channel table including HSDPA channels of FS-K74 and measuring test model 5.

The following parameters of these channels are determined by the CDP measurement:

Type: Type of channel (active channels only). If the modulation type of a channel can vary (HS-PDSCH, in the case of an analyzer equipped with FS-K74 only), the value of the modulation type measured by the firmware application will be appended to the channel type. Data channels that do not have a type that can be fully recognized are of type CHAN.

Symbol Rate: Symbol rate at which the channel is transmitted (7.5 kps to 960 kps).

Chan #: Number of the channel spreading code (0 to [spreading factor-1]).

Status: Status display. Unassigned codes are considered to be inactive.

TFCI: Indication whether the data channel uses TFCI symbols.

PilotL: Number of pilot bits of the channel.

Pwr Abs / Pwr Rel: Indication of the absolute and relative channel power (referenced to the CPICH or the total power of the signal).

T Offs: Timing offset. Offset between the start of the first slot of the channel and the start of the analyzed 3GPP FDD frame.

In *CODE CHAN AUTOSEARCH MODE*, a data channel is considered to be active if the required pilot symbols (see 3GPP specification, exception: PICH) are to be found at the end of each slot. In addition, the channel should have minimum power (see *INACT CHAN THRESHOLD* softkey). In *CODE CHAN PREDEFINED* mode, all channels that are included in the user-defined channel table are marked as active.

IEC/IEEE bus command: :CALCulate<1>:FEED "XTIM:CDP:ERR:CTABLE"



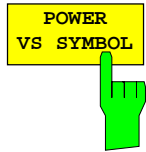

The *POWER VS SYMBOL* softkey selects the "power versus symbol" display mode.

'Power versus symbol' represents the relative symbol power in a selected channel within a selected slot. The number of symbols depends on the code class of the selected channel.

$$NOF_{Symbols} = 10 \cdot 2^{(8-Code\ Class)}$$

The displayed value is the ratio of the symbol power and the reference power. The total power of the selected channel or the power of the CPICH is used as the reference power. The reference power depends on the position of the *POWER REF [TOT] / CPICH* softkey in the *SETTINGS* menu.

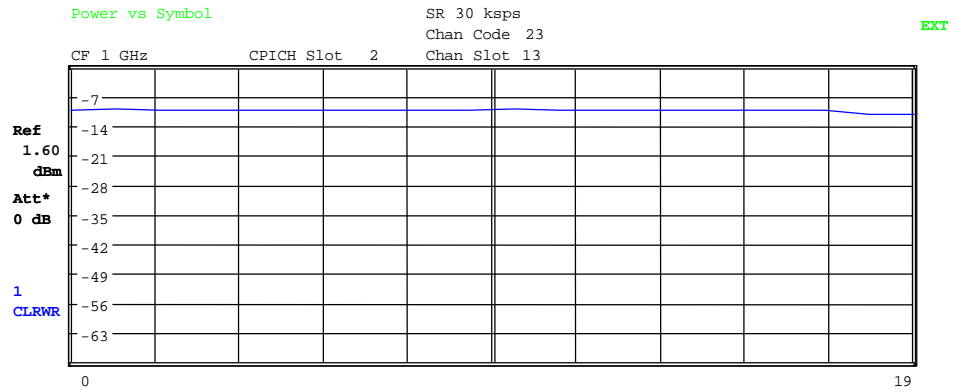

Fig. 6-24 Power versus symbol for one slot of a channel with 20 symbols

IEC/IEEE bus command: :CALCulate<1>:FEED  
"XTIM:CDP:PVSymbol"

Query of result: :TRACe<1>:DATA? TRACe2

Output: List of symbol power values deviating from the reference power

Format: Val<sub>1</sub>, Val<sub>2</sub>, ..., Val<sub>NOF</sub>

Unit: [dB]

Quantity:  $NOF_{Symbols} = 10 \cdot 2^{(8-Code\ Class)}$

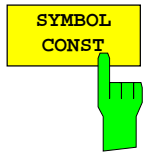

The *SYMBOL CONST* softkey selects the display of the symbol constellation diagram.

The symbols are displayed for the selected channel (red marking in the CDP diagram) and the selected slot (red marking in the power-versus-slot diagram).

It is possible to display the constellation diagram for unassigned codes (red marking in the CDP diagram for a code represented in blue), but the results are not meaningful, as the unassigned code channel does not contain data.

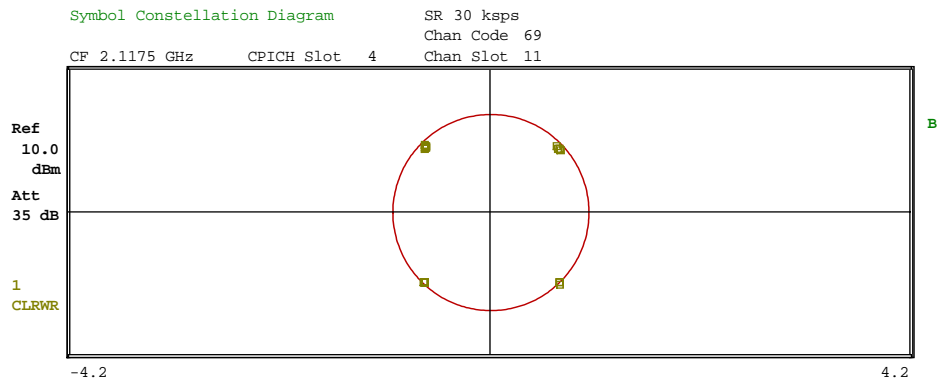

Fig. 6-25 Symbol constellation diagram

For HSDPA data channels, the modulation type can vary according to 3GPP. If the analyzer is equipped with FS-K74, this will be taken into account by switching the diagram according to the modulation type of the channel.

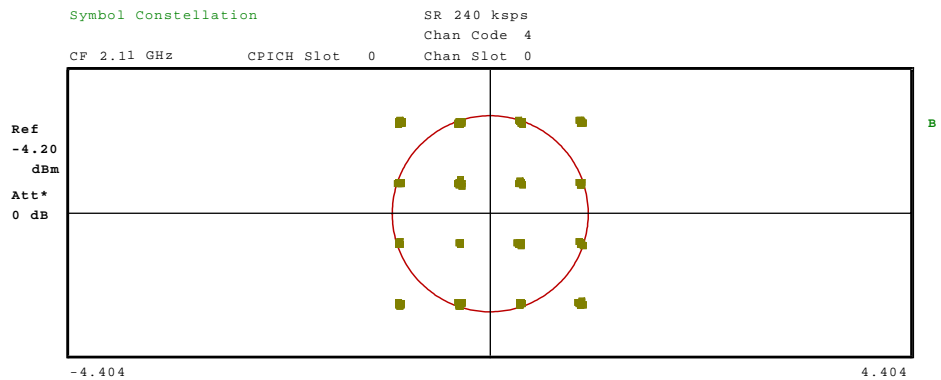
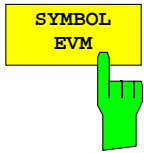

Fig. 6-26 Symbol constellation diagram for 16QAM

For orientation, the unit circle is added to the figure.

IEC/IEEE bus command: :CALCulate2:FEED "XTIM:CDP:SYMB:CONS"



The *SYMBOL EVM* softkey activates the symbol error vector magnitude display. The EVM is displayed for the selected channel (red marking in the CDP diagram) and the selected slot (red marking in the power-versus-slot diagram). It is possible to display the symbol error vector magnitude for unassigned codes (red marking in the CDP diagram for a code represented in blue), but the results are not valid.

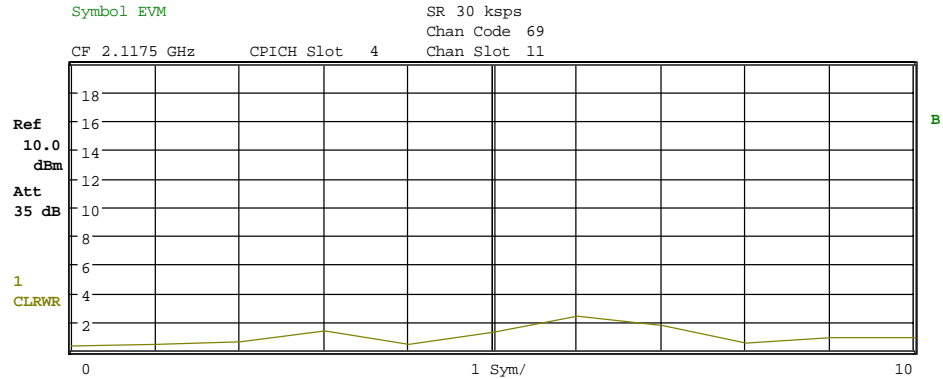

Fig. 6-27 Error vector magnitude for the selected slot of the selected channel  
IEC/IEEE bus command: :CALCulate2:FEED "XTIM:CDP:SYMB:EVM"



The *BITSTREAM* softkey activates the bit stream display. The determined bits are displayed for the selected channel (red marking in the CDP diagram) and the selected slot (red marking in the power-versus-slot diagram).

Depending on the channel type and the symbol rate at which the channel is transmitted, specific symbols can be "switched off" in a slot, i.e. power 0 is transmitted instead of these symbols. The results of the bit determination are invalid for such symbols. Such invalid bits are marked with "x" in the diagram.

While it is possible to display the bit stream for unused codes (red marking in the CDP diagram for a code displayed in blue), the missing data means that the results are not very informative. In this case, "-" is used to indicate that all of the bits are invalid.

In the bit stream diagram, the bits of the individual fields of active data channels are marked in different colours. The colour legend is displayed in the header of the figure.

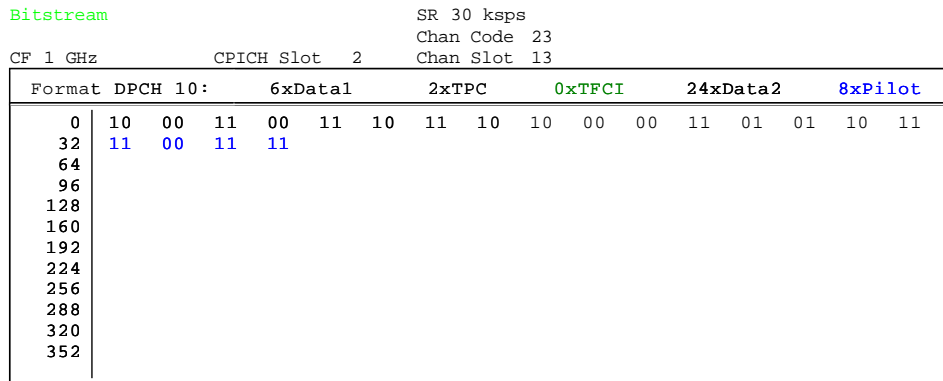

Fig. 6-28 Demodulated bits for the selected slot of the selected channel

If some of the pilot symbols of the selected slot of the DPCH are not correct, these symbols are marked with the colour magenta.

Bitstream SR 30 kbps  
Chan Code 23  
Chan Slot 13

CF 1 GHz CPICH Slot 2

|     | Format | DPCH 10: | 6xData1  | 2xTPC | 0xTFCI   | 24xData2 | 8xPilot |
|-----|--------|----------|----------|-------|----------|----------|---------|
| 0   | 10     | 00 11    | 00 11 10 | 11 10 | 10 00 01 | -- 01 01 | -- 11   |
| 32  | 01     | 00 11    | 11       |       |          |          |         |
| 64  |        |          |          |       |          |          |         |
| 96  |        |          |          |       |          |          |         |
| 128 |        |          |          |       |          |          |         |
| 160 |        |          |          |       |          |          |         |
| 192 |        |          |          |       |          |          |         |
| 224 |        |          |          |       |          |          |         |
| 256 |        |          |          |       |          |          |         |
| 288 |        |          |          |       |          |          |         |
| 320 |        |          |          |       |          |          |         |
| 352 |        |          |          |       |          |          |         |

Fig. 6-29 Demodulated bits with pilot symbols

For HSDPA data channels, the modulation type can vary. Depending on the modulation type, the number of bits that belong to one symbol will change. In the case of an analyzer equipped with FS-K74, the diagram will be switched according to the modulation type of the channel.

Bitstream SR 240 kbps  
Chan Code 4  
Chan Slot 0

CF 2.11 GHz CPICH Slot 0

|           | Format | HSPDSCH: | 640xData1 | 0xTPC | 0xTFCI | 0xData2 | 0xPilot |      |      |
|-----------|--------|----------|-----------|-------|--------|---------|---------|------|------|
| Ref       | 0      | 1010     | 1000      | 0010  | 0010   | 1011    | 1110    | 1101 | 0110 |
|           | 32     | 0110     | 1011      | 1100  | 0101   | 1110    | 0111    | 1111 | 1011 |
| -4.20 dBm | 64     | 1001     | 0010      | 0110  | 1001   | 0100    | 1101    | 1111 | 0011 |
|           | 96     | 1000     | 0111      | 0101  | 0011   | 0000    | 0110    | 0000 | 0000 |
| Att* 0 dB | 128    | 1010     | 0010      | 1011  | 1111   | 1001    | 0000    | 1110 | 0001 |
|           | 160    | 0101     | 1001      | 1000  | 1111   | 0100    | 0110    | 0011 | 1100 |
|           | 192    | 0100     | 1011      | 0101  | 0001   | 1001    | 1010    | 0111 | 1100 |
|           | 224    | 0111     | 0111      | 1011  | 1000   | 0111    | 0100    | 0111 | 0110 |
|           | 256    | 1110     | 1010      | 1001  | 0110   | 0100    | 0011    | 0100 | 0100 |
|           | 288    | 1010     | 0000      | 0011  | 0111   | 1000    | 0100    | 1001 | 1101 |
|           | 320    | 1001     | 1000      | 1110  | 0000   | 0000    | 1011    | 0110 | 1101 |
|           | 352    | 0111     | 0011      | 1001  | 0010   | 0111    | 1101    | 0010 | 0101 |

Fig. 6-30 Demodulated bits for the selected slot of the selected channel in the case of 16QAM

IEC/IEEE bus command: :CALCulate2:FEED "XTIM:CDP:BSTream"

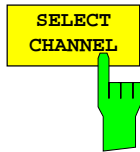

The *SELECT CHANNEL* softkey activates the selection of a channel for the display modes *CDP PWR RELATIVE/ABSOLUTE*, *POWER VS SLOT*, *SYMBOL CONST* and *SYMBOL EVM*.

There are two ways of entering the channel numbers:

- Entry of channel number and spreading factor, separated by a decimal point. If the channel number and the spreading factor are entered simultaneously, the entered channel is selected and marked in red if an active channel is involved. For the display, the channel number entered is converted on the basis of spreading factor 512. For unused channels, the code resulting from the conversion is marked.

Example: Entry 5.128

Channel 5 is marked at spreading factor 128 (30 ksps) if the channel is active, otherwise code 20 at spreading factor 512.

- Entry of a channel number without a decimal point.

In this case, FS-K72/K74 interprets the entered code as based on spreading factor 512. If the code entered corresponds to a used channel, the entire associated channel is marked. If the code corresponds to an unused channel, only the code entered is marked.

Example: Entry 20

Code 20 is marked at spreading factor 512 if there is no active channel on this code. If for instance channel 5 is active at spreading factor 128, the entire channel 5 is marked.

If the entered code corresponds to an active channel, the entire associated channel is marked. If it corresponds to a gap between the channels, only the entered code is marked.

If the code number is modified using the rotary knob, the red marking changes its position in the diagram only if the code number no longer belongs to the marked channel. The step width of the changed rotary knob position refers to a spreading factor of 512.

IEC/IEEE bus command: `:[SENSe:]CDPower:CODE 0 to 511`

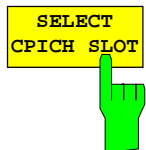

The *SELECT CPICH SLOT* softkey activates the selection of the slot number for the display modes *POWER VS SLOT*, *SYMBOL CONST*, *SYMBOL EVM* and *BITSTREAM*.

To avoid ambiguities that may occur due to the permissible timing offsets, the slot number is defined on the basis of the CPICH (i.e. calculated in steps of 2560 chips starting from the beginning of the frame). The desired slot of the selected channel has to be converted according to its timing offset.

Example: Slot 0 of the CPICH is set. The selected channel (red marker in the CDP diagram) has a timing offset of 2816 chips, i.e. slot 0 of the channel is delayed by 2816 chips with respect to the frame start. Slot 0 of the CPICH therefore corresponds to slot 14 of the last frame of the channel.

When the slot number is entered, the red marking in the power-versus-slot diagram changes its position in steps of 2560 chips.

IEC/IEEE bus command: `:[SENSe:]CDPower:SLOT 0 to 14`

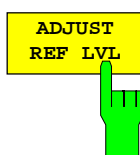

The *ADJUST REF LVL* softkey adjusts the reference level of the FSU to the measured channel power. This ensures that the settings of the RF attenuation and the reference level are optimally adjusted to the signal level without overloading the FSU or limiting the dynamic range by an S/N ratio that is too small.

IEC/IEEE bus command: `SENS:POW:ACH:PRES:RLEV`

Measurement Configuration – CHAN CONF hotkey

CHAN CONF hotkey

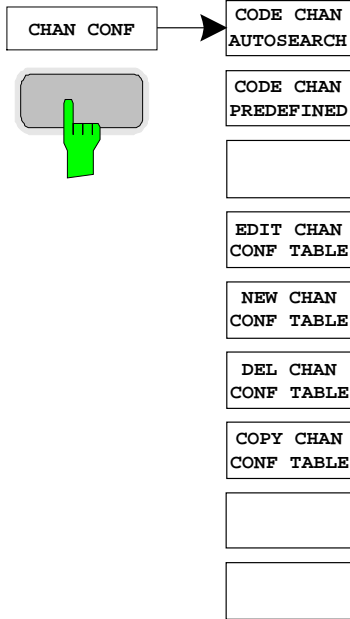

The *CHAN CONF* hotkey opens a submenu with different configurations for measurements. In this submenu, predefined channel tables can be selected as a basis for code domain measurements.

When the hotkey is selected, a table including the channel tables stored on the measuring instrument's hard disk is opened. The table merely provides an overview; a table for the measurement can be selected only after actuating the *CODE CHAN PREDEFINED* softkey.

IEC/IEEE bus command:

```
:CONFigure:WCDPower[:BTS]:CTable:CATalog?
```



The *CODE CHAN AUTOSEARCH* softkey allows code domain power measurements in the automatic search mode. In this mode, the entire code domain (all permissible symbol rates and channel numbers) is searched for active channels. Detecting an active channel is performed by a comparison with the pilot symbols to be expected after despreading. Only channels with pilot symbols can be detected as active channels. If the pilot symbols of a channel are either missing or incomplete, the channel is not recognized as active. An exception to this rule is the special channel PICH which can be recognized as active channel also in the automatic search mode.

Synchronization channels CPICH, PCCPCH, PSCH and SSCH are assumed to be present by CDP analysis and are added to the channel table for each measurement.

The *CODE CHAN AUTOSEARCH* mode is the preset search mode when starting CDP analysis. Its main purpose is to provide the user with an overview of the channels contained in the signal. If the signal contains channels that are not detected as being active in the automatic search mode, CDP analysis can be performed with the channel configurations predefined by the user by switching to *CODE CHAN PREDEFINED* mode.

IEC/IEEE bus command:

```
CONFigure:WCDPower[:BTS]:CTable[:STATE] OFF
```

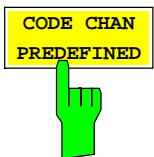

The *CODE CHAN PREDEFINED* softkey activates the predefined channel table mode. No search for active channels in the code domain is performed in this mode, but the channels contained in a channel table defined prior to the measurement are assumed to be active. The code domain power measurement and all further evaluations are carried out for these channels.

When the softkey is selected, a table containing all channel tables stored in the measuring instrument is opened. CDP analysis is switched to the predefined channel table. When the next measurement is started, the power is measured according to this mode. The last table of the automatic search mode is first taken as a basis for the measurement. This table is available under the *RECENT* entry.

Switching to one of the predefined channel tables is done by selecting the corresponding table entry and pressing one of the unit keys. Starting with the next measurement, the selected channel table is taken as a basis for the sweep. A check mark indicates the selected channel table.

In the factory-ready state, FS-K72/K74 has the following channel tables stored on the measuring instrument:

- Channel model 1 to 3GPP with 16/32/64 channels
- Channel model 2 to 3GPP
- Channel model 3 to 3GPP with 16/32 channels
- Channel model 4 containing CPICH and PCCPCH

If the analyzer is equipped with FS-K74, the following tables will be offered additionally:

- Channel model 5 to 3GPP with 2/4/8 HS-PDSCH and 6/14/30 DPCH

IEC/IEEE bus command:

```
CONFigure:WCDPower[:BTS]:CTABLE[:STATE] ON
CONFigure:WCDPower[:BTS]:CTABLE:SElect "3GB_1_32"
```

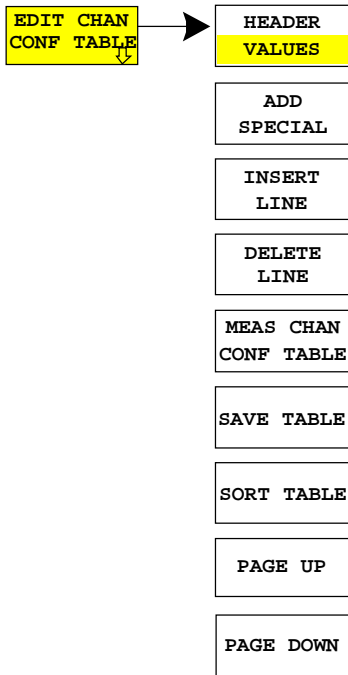

The *EDIT CHAN CONF TABLE* softkey opens a channel table in which the user can edit the channel configuration. In addition, a submenu is opened that provides access to the softkeys required for editing the table.

| EDIT CHANNEL TABLE |                                                       |        |      |              |       |          |        |
|--------------------|-------------------------------------------------------|--------|------|--------------|-------|----------|--------|
| NAME:              | 3GB_5_4                                               |        |      |              |       |          |        |
| COMMENT:           | 3GPP Base Station Test Model 5 30 Channels 8 HS_PDSCH |        |      |              |       |          |        |
| CHANNEL            | SYMBOL                                                | CHAN # | USE  | TIMING OFFS. | PILOT | CDP REL. | STATUS |
| TYPE               | RATE[kbps]                                            |        | TFCI | [CHIPS]      | BITS  | [dB]     |        |
| CPICH              |                                                       | 0      |      |              | ---   | 0.0000   | ACTIVE |
| PCCPCH             | 15                                                    | 1      |      |              | ---   | 0.0000   | ACTIVE |
| SCCPCH             | 15                                                    | 3      |      | 0            | 0     | 0.0000   | ACTIVE |
| PICH               |                                                       | 16     |      | 0            | ---   | 0.0000   | ACTIVE |
| HSSCCH             | 30                                                    | 29     |      | 0            | ---   | 0.0000   | ACTIVE |
| HSSCCH             | 30                                                    | 9      |      | 0            | ---   | 0.0000   | ACTIVE |
| HSPDSCH            | 240                                                   | 13     |      | 0            | ---   | 0.0000   | ACTIVE |
| HSPDSCH            | 240                                                   | 12     |      | 0            | ---   | 0.0000   | ACTIVE |
| HSPDSCH            | 240                                                   | 5      |      | 0            | ---   | 0.0000   | ACTIVE |
| HSPDSCH            | 240                                                   | 4      |      | 0            | ---   | 0.0000   | ACTIVE |
| DPCH               | 30                                                    | 15     | NO   | 22016        | 8     | 0.0000   | ACTIVE |
| DPCH               | 30                                                    | 23     | NO   | 34304        | 8     | 0.0000   | ACTIVE |
| DPCH               | 30                                                    | 68     | NO   | 13312        | 8     | 0.0000   | ACTIVE |
| DPCH               | 30                                                    | 76     | NO   | 11520        | 8     | 0.0000   | ACTIVE |
| DPCH               | 30                                                    | 82     | NO   | 36608        | 8     | 0.0000   | ACTIVE |
| DPCH               | 30                                                    | 90     | NO   | 28672        | 8     | 0.0000   | ACTIVE |
| DPCH               | 30                                                    | 5      | NO   | 15104        | 8     | 0.0000   | ACTIVE |
| DPCH               | 30                                                    | 11     | NO   | 5888         | 8     | 0.0000   | ACTIVE |
| DPCH               | 30                                                    | 17     | NO   | 256          | 8     | 0.0000   | ACTIVE |
| DPCH               | 30                                                    | 27     | NO   | 22528        | 8     | 0.0000   | ACTIVE |
| DPCH               | 30                                                    | 64     | NO   | 7680         | 8     | 0.0000   | ACTIVE |
| DPCH               | 30                                                    | 72     | NO   | 4608         | 8     | 0.0000   | ACTIVE |
| DPCH               | 30                                                    | 86     | NO   | 7680         | 8     | 0.0000   | ACTIVE |
| DPCH               | 30                                                    | 94     | NO   | 15616        | 8     | 0.0000   | ACTIVE |

Fig. 6-31. Table for editing a channel configuration

Basically, any channel table stored on the instrument's hard disk can be edited as required. An edited table is not stored automatically but only after the *SAVE TABLE* softkey is pressed. This prevents a table

from being overwritten inadvertently (e.g. a channel model).

If the user edits the table currently used in CDP analysis, the edited table is taken as a basis for the next measurement immediately after it is stored. Thus, any modifications to the table are immediately shown. Here, too, the *SAVE TABLE* softkey must be pressed to store the edited table on the instrument's hard disk.

If the user edits a table stored on the hard disk but currently not active, the modifications become visible only after storage (*SAVE TABLE* softkey) and subsequent activation.

If the *SYMBOL RATE* or the *CHAN #* of a channel is changed, the instrument checks for code domain conflicts after confirmation of the entry with one of the unit keys. If a code domain conflict is detected, the channels involved are marked with an asterisk. The user has the possibility of eliminating the code domain conflict. If a table with code domain conflicts is used in CDP analysis, the results obtained are not valid.

The *HEADER/VALUES* softkey switches between editing of the channel table header or its values.

*HEADER* allows the table header to be edited, i.e. the name and the comment. By changing the table name, overwriting of a table that has already been stored is prevented. The table name may contain max. 8 characters.

IEC/IEEE bus command:

```
:CONFigure:WCDPower[:BTS]:CTable:NAME "NEW_TAB"
```

*VALUES* allows the entries of a channel table to be edited. The following parameters are available for each channel of a table (confirm each entry with one of the unit keys):

- SYMBOL RATE:** Symbol rate at which a channel is transmitted. This entry cannot be edited for channels whose symbol rate is defined by the standard (e.g. synchronization channels). In the case of special channels, the channel type is entered instead of the symbol rate.
- CHAN #:** Number of channel in the associated transmission class. The validity of the entered channel number for the selected transmission rate is checked when entered; invalid entries are rejected.
- USE TFCI:** Indicates whether a channel contains TFCI symbols. This information is required for determining the slot format of a channel. The entry cannot be edited for channels that do not contain any TFCI information.
- TIMING OFFSET:** Timing offset of a channel. The expected timing offset is the channel offset relative to the CPICH, specified in chips. This entry cannot be edited for channels that have no timing offset.
- PILOT BITS:** Number of pilot bits of a channel. This information is required for determining the slot format. The entry cannot be edited for channels containing no

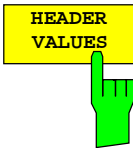



CDP REL.: pilot symbols. The entry is made in bits. Information about relative channel power. This entry cannot be edited and exists only for the *RECENT* table; it is used for indicating low-power channels.

STATUS: Channel status (active/inactive). Setting the channel status to inactive excludes a channel entered in the table from CDP analysis without the complete channel line having to be cleared from the table. Only channels with active status are taken into account in CDP analysis.

IEC/IEEE bus commands:

```
:CONFigure:WCDPower[:BTS]:CTable:DATA
8,0,0,0,0,0,1,0.00,8,1,0,0,0,0,1,0.00,7,1,0,25
6,8,0,1,0.00

:CONFigure:WCDPower[:BTS]:CTable:COMMENT
"Comment for new table"
```

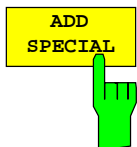

The *ADD SPECIAL* softkey is used to add special channels to the channel table. For an analyzer equipped with FS-K72, the PICH and SCCPCH special channels, which are included in the 3GPP test models, can presently be added. Only one channel of each type may be added per channel table.

If the analyzer is equipped with FS-K74, the channel types of HSDPA (HSSCCH and HSPDSCH) can be selected and added to the channel table as well.

IEC/IEEE bus command:

```
-- (included in command CONF:WCDP:CTAB:DATA)
```

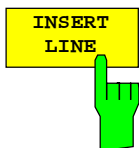

The *INSERT LINE* softkey inserts a new line into the table. In this line, entries can be made in any order. A channel is included in CDP analysis only if all required entries have been made in the list.

IEC/IEEE bus command: --

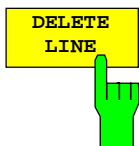

The *DELETE LINE* softkey deletes a marked line from the table.

IEC/IEEE bus command: --

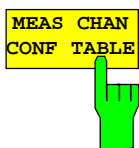

The *MEAS CHAN CONF TABLE* softkey starts a measurement in the *CODE CHAN AUTOSEARCH* mode. The measurement results are entered in the channel table currently open. This softkey is available only in the *CODE CHAN AUTOSEARCH* mode.

IEC/IEEE bus command: --

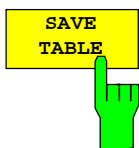

The *SAVE TABLE* softkey saves the table under the specified name. *Caution:* Editing a channel model and storing it under its original name will overwrite the model.

IEC/IEEE bus command:

```
-- (automatic storage with remote control)
```

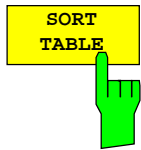

The *SORT TABLE* softkey sorts a channel table according to symbol rates (in descending order) and, for channels of the same symbol rate, according to channel numbers (in ascending order).

IEC/IEEE bus command: --

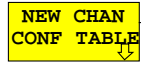

- NEW CHAN CONF TABLE
- CHAN TABLE HEADER
- CHAN TABLE VALUES
- ADD PICH
- INSERT LINE
- DELETE LINE
- MEAS CHAN CONF TABLE
- SAVE TABLE
- SORT TABLE
- PAGE UP
- PAGE DOWN

The *NEW CHAN CONF TABLE* softkey opens a submenu identical to that opened by the *EDIT CHAN CONF TABLE* softkey. In contrast to *EDIT CHAN CONF TABLE*, *NEW CHAN CONF TABLE* opens a table in which only the synchronization channels are entered; the table name is not yet defined.

| EDIT CHANNEL TABLE |                   |        |          |                      |            |               |        |
|--------------------|-------------------|--------|----------|----------------------|------------|---------------|--------|
| NAME:              |                   |        |          |                      |            |               |        |
| COMMENT:           |                   |        |          |                      |            |               |        |
| CHANNEL TYPE       | SYMBOL RATE[kbps] | CHAN # | USE TFCI | TIMING OFFS. [CHIPS] | PILOT BITS | CDP REL. [dB] | STATUS |
| CPICH              |                   | 0      |          |                      | ---        | 0.0000        | ACTIVE |
| PCCPCH             | 15                | 1      |          |                      | ---        | 0.0000        | ACTIVE |

Fig. 6-32 Creating a new channel configuration



The *DEL CHAN CONF TABLE* softkey deletes a selected table from the list. The table currently active in the *CODE CHAN PREDEFINED* mode cannot be deleted.

IEC/IEEE bus command:  
:CONFigure:WCDPower[:BTS]:CTable:DELeTe

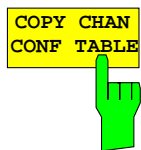

The *COPY CHAN CONF TABLE* softkey copies a selected table. The user is prompted to enter the name the copy is to be saved under.

IEC/IEEE bus command:  
:CONFigure:WCDPower[:BTS]:CTable:COpy "CTAB2"

### Configuration of CDP Measurement – SETTINGS hotkey

SETTINGS hotkey

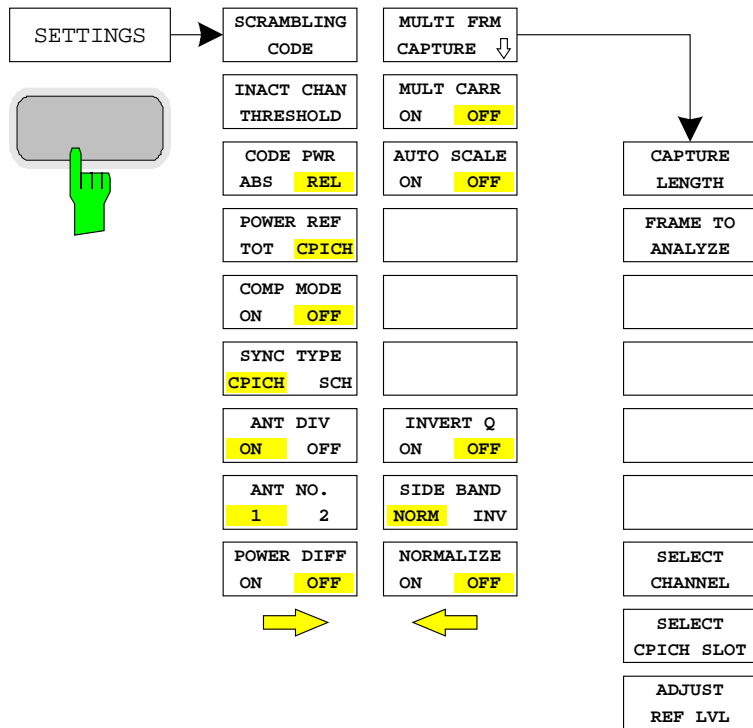

The *SETTINGS* hotkey opens a submenu with softkeys for setting parameters for the CDP measurement.

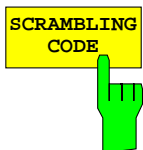

The *SCRAMBLING CODE* softkey opens a window for entering the scrambling code.

The scrambling codes are divided into 512 sets, each consisting of a primary scrambling code and 15 secondary scrambling codes.

The primary scrambling codes consist of scrambling codes  $n=16*i$  where  $i=0$  to 511. The  $i$ :th set of secondary scrambling codes consists of scrambling codes  $16*i+k$ , where  $k=1$  to 15. The scrambling code is input in hex format. According to the 3GPP specification, the last digit denotes the number of the secondary scrambling code ( $k \in [1 \dots 15] = [1 \dots F]$ ). The digit before the last digit denotes the primary scrambling code ( $k = 0, i \in [0 \dots 511] = [0 \dots FF]$ ).

Example: To enter the primary scrambling code number '1', the digits '10' need to be entered. ( $i = 1, k = 0$ )

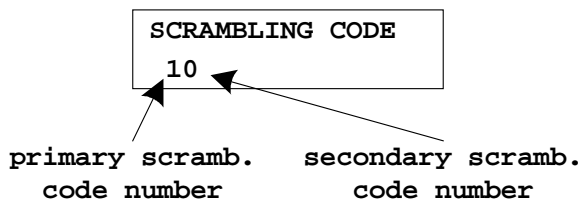

The entered scrambling code has to coincide with that of the signal. Otherwise, a CDP measurement of the signal is not possible.

IEC/IEEE bus command: : [SENSe: ]CDPower:LCODE[:VALue] #H2

INACT CHAN  
THRESH



The *INACT CHAN THRESH* softkey activates the entry of the minimum power which a single channel should have as compared to the total signal in order to be considered an active channel.

Channels that are below the specified threshold are considered to be not active irrespective of whether they contain pilot symbols. Channels that are not active appear in blue in the CDP diagram.

The two measurements *COMPOSITE EVM* and *PEAK CODE DOMAIN ERR*, specified as measurements on the total signal, are performed with the aid of the list of active channels. These two measurements are falsified whenever active channels are recognized as not active (see above example) or if unassigned codes receive the status "assigned channel". *INACT CHAN THRESHOLD* is therefore used to influence the results of the two measurements.

The default value is -60 dB, which allows all channels of signals such as the 3GPP test signals to be detected in CDP analysis. If not all channels in the signal are automatically detected, *INACT CHAN THRES* has to be decremented.

IEC/IEEE bus command:

```
: [SENSE:]CDPower:ICTReshold -100dB to +10dB
```

CODE PWR  
ABS REL



The *CODE PWR* softkey toggles the display mode of the code domain power display (see *CODE DOM POWER*).

REL: Selects relative scaling of the CDP measurement (default). The power reference depends on the adjustment of *POWER REF*.

CPICH: Relative power of the channels is referenced to the CPICH power

TOT: Relative power of the channels is referenced to the total power

ABS: Selects absolute scaling of the CDP measurement. The values are displayed in dBm.

IEC/IEEE bus command:

```
Rel. scaling: :CALCulate<1>:FEED "XPOW:CDP:RATio"
```

```
Abs. scaling: :CALCulate<1>:FEED
```

```
"XPOWer:CDP:ABSolute"
```

```
:CALCulate<1>:FEED "XPOW:CDP"
```

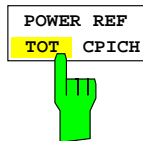

The *POWER REF TOT / CPICH* softkey determines the reference power for the relative power displays:

**TOT** All the relative powers (display modes *CDP RELATIVE* and *POWER VS SLOT*) are referenced slot by slot to the total signal power in the slot involved.

**CPICH** The reference power is that of the CPICH in the relevant slot.

The default setting of the softkey is *CPICH*.

Since 3GPP specifies a slot-specific power control for every channel, the total power of the signal will change from slot to slot in accordance with the power control of the individual channels. As a result, with activated power control and reference to the total power of the signal, a relative CDP display versus the slot number (*POWER VS SLOT*) does not necessarily represent the power control of the selected channel.

Example:

If the signal (theoretically) contains only one data channel whose power is controlled, and if the power is referenced to the total power of the signal (which is formed only by the contribution of this data channel), a straight line appears in the *POWER VS SLOT* diagram instead of the expected power staircase. Consequently, the reference value *TOT* of the relative displays is informative only if the signal does not contain power control.

By contrast, the *CPICH* setting also reflects the exact characteristic of the power versus the slot number in a selected channel for signals with power control. Since the CPICH is never power controlled, this yields the same reference value in every slot.

IEC/IEEE bus command: `:[SENSE:]CDPower:PREference TOTAL|CPICH`

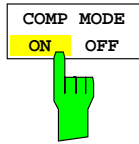

The *COMP MODE ON/OFF softkey* enables an extended channel search to evaluate compressed mode channels. In the frame of compressed mode channels, some slots can be suppressed. Furthermore the spreading factor of the compressed channels can be decreased and an varied pilot sequence is sent. By enabling the compressed mode measurement, this channel properties are considered.

Default setting is OFF.

**OFF:** Standard channel search.  
The slot power (POWER VS SLOT display) of each slot is averaged to the symbols of one slot starting with the pilot symbols of the previous slot.

IEC/ IEEE bus command: :CDP:PCON PILOT

**ON:** Extended channel search considering the properties of compressed mode channels  
The slot power (POWER VS SLOT display) of each slot is averaged to the symbols of one slot starting with the first data symbol of the slot.

IEC/ IEEE bus command: :CDP:PCON SLOT

Channels that show compressed mode transmission are marked with the ending -CPRSD within the channel table.

The following pictures show the channel table of a signal with compressed channels and the code domain power display and power versus slot of such a channel.

 Channel Table

SR 480 kbps  
Chan Code 3  
CF 2.14 GHz CPICH Slot 0 Chan Slot 0

| Chan Type  | Symb Rate [ksp/s] | Chan# | Status | TFCI | PilotL [Bits] | Pwr Abs [dBm] | Pwr Rel [dB] | T Offs [Chips] |
|------------|-------------------|-------|--------|------|---------------|---------------|--------------|----------------|
| CPICH      | 15.0              | 0     | active | ---  | ---           | -23.60        | 0.00         | ---            |
| PSCH       | -.-               | ---   | active | ---  | ---           | -28.12        | -4.53        | ---            |
| SSCH       | -.-               | ---   | active | ---  | ---           | -26.52        | -2.93        | ---            |
| PCCPCH     | 15.0              | 1     | active | ---  | ---           | -23.60        | 0.00         | ---            |
| SCCPCH     | 15.0              | 3     | active | OFF  | 0             | -13.61        | 9.99         | 0              |
| PICH       | 15.0              | 16    | active | ---  | ---           | -28.61        | -5.01        | 30720          |
| DPCH-CPRSD | 960.0             | 2     | active | ON   | 16            | -23.61        | -0.01        | 2304           |
| DPCH-CPRSD | 480.0             | 3     | active | ON   | 16            | -23.60        | -0.00        | 2048           |
| DPCH-CPRSD | 240.0             | 4     | active | ON   | 16            | -23.61        | -0.02        | 1792           |
| DPCH-CPRSD | 120.0             | 6     | active | ON   | 16            | -23.60        | 0.00         | 1536           |

Ref 1.90 dBm  
Att\* 0 dB

Fig. 6-33 Channel table of a signal with compressed channels

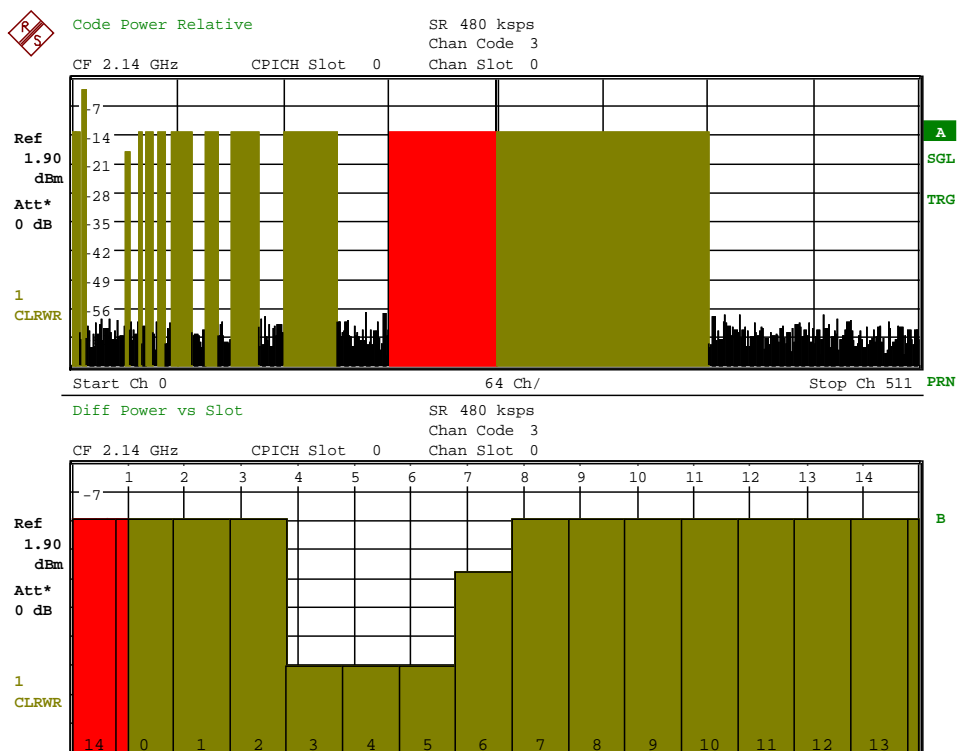
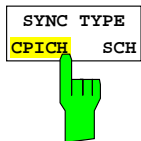

Fig. 6-34 Code domain power and power versus slot of a compressed channel



The *SYNC TYPE CPICH/SCH* softkey allows the user to choose between synchronization with or without CPICH. If *CPICH* is selected, FS-K72/K74 assumes that the CPICH control channel is present in the signal and attempts to synchronize to this channel. If the signal does not contain CPICH (test model 4 without CPICH), synchronization fails.

If *SCH* is selected, FS-K72/K74 synchronizes to the signal without assuming the presence of a CPICH. This setting is required for measurements on test model 4 without CPICH. While this setting can also be used with other channel configurations, it should be noted that the probability of synchronization failure increases with the number of data channels.

The default setting of the softkey is *CPICH*.

IEC/IEEE bus command:

: [SENSe<1 | 2>:]CDPower:STYPe CPICH | SCHannel

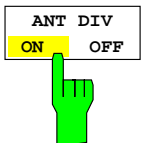

The *ANT DIV ON/OFF* softkey activates or deactivates the antenna diversity mode for CDP analysis. If the softkey is set to ON, analysis is carried out with diversity antenna 1 as a default setting (see *ANT NO. 1/2* softkey).

The default setting of the softkey is *OFF*

IEC/IEEE bus command: : [SENSe<1 | 2>:]CDPower:ANTenna OFF | 1 | 2

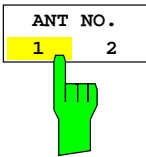

The *ANT NO. 1/2* softkey switches between diversity antennas 1 and 2. Depending on the softkey setting, FS-K72/K74 synchronizes to the CPICH of antenna 1 or antenna 2. The softkey is available only if the antenna diversity mode is active (*ANT DIV ON/OFF* softkey set to *ON*). The default setting of the softkey is 1.

IEC/IEEE bus command: `: [SENSe<1|2>:]CDPower:ANTenna OFF|1|2`

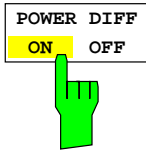

The *POW DIFF ON/OFF* softkey activates or deactivates the slot power difference calculation of the *POWER VERSUS SLOT* display. The default setting of the softkey is *OFF*

**OFF:** The slot power of each slot is displayed (*POWER VS SLOT* display).

**ON:** The slot power difference to the previous slot is displayed for each slot (*POWER VS SLOT* display).

IEC/ IEEE bus command: `: [SENSe<1|2>:]CDPower:PDIFf ON|OFF`

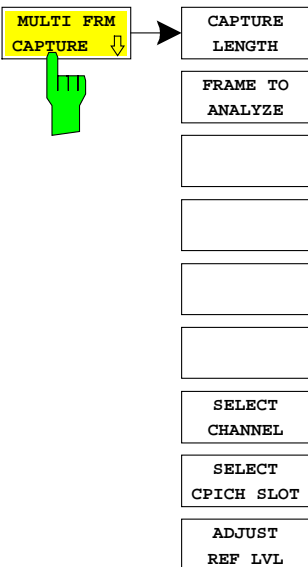

The Softkey *MULTI FRM CAPTURE* opens a submenu for specifying the parameters for multi-frame measurement. This measurement supports the data acquisition and evaluation of more than one 3GPP WCDMA frame. Depending on the analyser type that is used, several frames can be captured and evaluated.

The figure below shows the memory structure of the captured data. The size of the stored data depends on the parameter *CAPTURE LENGTH*, which defines the number of frames that are captured after a sweep is forced. If the parameter *CAPTURE LENGTH* has been changed, a new sweep must be started (*SINGLE SWEEP*) or must have been finished (*CONTINUOUS SWEEP*) in order to obtain valid measurement results for the specified range. The maximum number of storable frames depends on the trigger mode (*FREE RUN* or *EXT TRIG*). By changing the parameter *FRAME TO ANALYZE*, the frame number to be analyzed can be selected. The displayed results are refreshed if *FRAME TO ANALYZE* has been changed or a new sweep is started.

The *TRIGGER TO FRAME* time (TTF) is measured from the external trigger event to the start of the selected frame (*FRAME TO ANALYZE*). Therefore, the TTF of frame 0 is usually smaller than one slot (<667 us). If frame 1 is selected, the displayed TTF is between 10 ms and 10.667 ms. The TTF time is displayed in the result summary. For the TTF time of frame *n*, the following equation is used:

$$TTF_n = TTF_0 + n \cdot 10 \text{ ms}$$

The maximum number of captured frames depends on the memory size and the trigger mode.

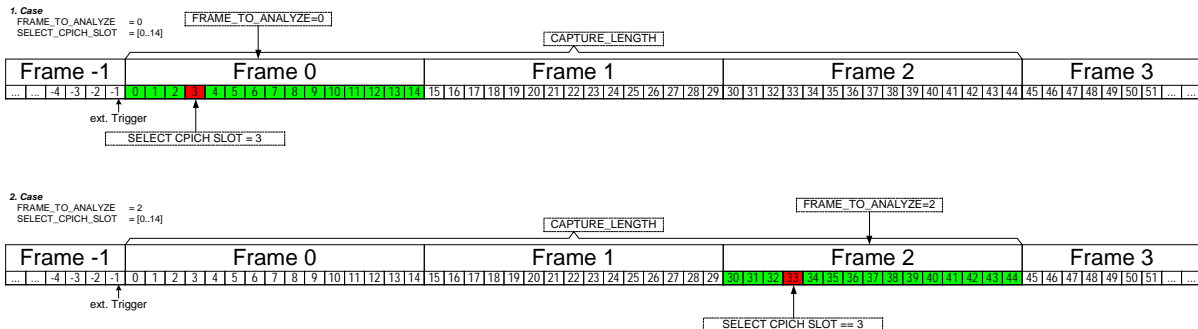
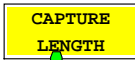

Fig. 6-35 Data scheme of the captured and analyzed frames



Table 6-2: Maximum number of captured frames

| Analyzer       | Downlink (K72/K74)<br>EXT TRIGGER | Downlink (K72/K74)<br>FREE RUN | Uplink (K73)<br>EXT TRIGGER | Downlink (K73)<br>FREE RUN |
|----------------|-----------------------------------|--------------------------------|-----------------------------|----------------------------|
| FSP            | ---                               | ---                            | 1 slot                      | 1 slot                     |
| FSP (with B70) | 3 frames                          | 2 frames                       | 3 frames                    | 2 frames                   |
| FSU            | 3 frames                          | 2 frames                       | 3 frames                    | 2 frames                   |
| FSQ            | 100 frames                        | 100 frames                     | 100 frames                  | 100 frames                 |



The softkey *CAPTURE LENGTH* enables an entry window for determining the number of frames that are to be captured at each sweep.

IEC/IEEE bus command:

`:[SENSe:]CDPower:IQLength <numeric value>`

Range: FSU / FSP-B70 (*free run*): <numeric value> [1... 2]  
 FSU / FSP-B70 (*ext. Trig*): <numeric value> [1... 3]  
 FSQ: <numeric value> [1... 100]

Unit: []

Default: 1

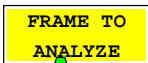

The softkey *FRAME TO ANALYZE* enables an entry window for selecting the frame number to be analyzed.

IEC/IEEE bus command:

`:[SENSe:]CDPower:FRAME[:VALue] <numeric value>`

This command selects one frame of the captured data, which is evaluated.

Range: <numeric value> [0... CAPTURE\_LENGTH - 1]

Unit: []

Default: 0

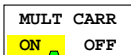

The *MULT CARR ON/OFF* softkey effects the following measurements:

- POWER
- CODE DOMAIN POWER
- SIGNAL STATISTICS

ACLR, OCCUPIED BANDWIDTH and SPECTRUM EMISSION MASK measurements refer to a single carrier. MULT CARR ACLR can handle both single and multi carrier signals.

If the MULT CARR softkey is switched to ON the adjust reference level procedure ensures that the settings of RF attenuation and reference level are optimally adjusted for measuring a multi carrier signal. Even if one of the channels next to the analyzed one has higher power than the analyzed one the device is set to a non RF or IF overload condition.

If the MULT CARR softkey is in its default state OFF, the adjust reference level procedure works as if a single carrier signal is present, which is a faster routine.

IEC/IEEE bus command: `:CONF:WCDP:BTS:MCAR:STAT ON | OFF`

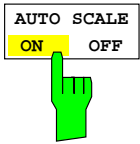

The *AUTO SCALE ON/OFF* softkey is available if the *MULT CARR* softkey is switched ON. The autoscaling function automatically changes the level settings if the center frequency is changed to another carrier. The level settings are derived from the latest adjust reference level procedure. In default state *AUTO SCALE* is turned ON, but it can be turned OFF if the functionality is not needed.

IEC/IEEE bus command: :CONF:WCDP:BTS:ASC:STAT ON | OFF

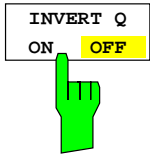

The *INVERT Q* softkey inverts the sign of the Q component of the signal. In the default setting, the softkey is deactivated.

IEC/IEEE bus command: :[SENSe:]CDPower:QINVert OFF | ON

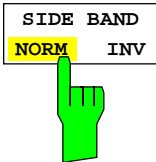

The *SIDE BAND NORM / INV* softkey is used to perform the measurement in the normal (NORM) and in the inverted position (INV).

**NORM** The normal position allows the measurement of RF signals from the base station.

**INV** The inverted position is useful for measurements on IF modules or components in the case of spectral inversion.

The default setting is *NORM*.

IEC/IEEE bus command: :[SENSe:]CDPower:SBAND NORMal | INVers

**Explanation:** Pressing the *SIDE BAND [INV]* softkey or activating the *INVERT Q* softkey inverts the baseband spectrum. When the two softkeys are active, the spectrum is inverted twice and in the same position as the transmit signal.  
(normal → inverted → normal)

Therefore, if the two softkeys are active, synchronization to the signal is still possible but the EVM is reduced. This is due to inverted frequency response correction.

**Measuring signals in inverted position:**

If a signal in inverted position is to be measured, only one of the softkeys *SIDE BAND [INV]* and *INVERT Q* should be pressed. The following combination is useful because, in this case, the EVM is not reduced by inverted frequency response correction.

SIDE BAND [NORM]  
INVERT Q [ON]

IEC/IEEE bus command: :[SENSe:]CDPower:SBAND NORMal  
:[SENSe:]CDPower:QINVert ON



The *NORMALIZE ON / OFF* softkey eliminates the DC offset of the signal. The default setting is OFF.

IEC/IEEE bus command : [SENSe:]CDPower:NORMalize OFF

### Frequency Settings – *FREQ* key



CENTER

The *FREQ* key opens a submenu for changing the measurement frequency.

CF-  
STEPSIZE

The *CENTER* softkey opens the window for manually entering the center frequency.

The permissible range of values for the center frequency is:

$$\text{minspan} / 2 \leq f_{\text{center}} \leq f_{\text{max}} - \text{minspan} / 2$$

$f_{\text{center}}$  center frequency

$\text{minspan}$  smallest selectable span > 0 Hz (10 Hz)

$f_{\text{max}}$  max. frequency

IEC/IEEE bus command: `FREQ:CENT 100MHz`

FREQUENCY  
OFFSET

The *CF STEPSIZE* softkey opens a submenu for setting the step size of the center frequency. The step size can be coupled to the span (frequency domain) or the resolution bandwidth (time domain) or it can be manually set to a fixed value. The softkeys are mutually exclusive selection keys.

The *FREQUENCY OFFSET* softkey activates the window for entering an arithmetic frequency offset which is added to the frequency axis labelling. The allowed range of values for the offset is -100 GHz to 100 GHz. The default setting is 0 Hz.

IEC/IEEE bus command: `FREQ:OFFS 10 MHz`

### Span Settings – *SPAN* key

The *SPAN* key is disabled for measurements in the CDP mode. For all other measurements (see *MEAS* key), the permissible span settings are described together with the measurement. The associated menu corresponds to that of the measurement in the base unit and is described in the manual for the base unit.

Level Settings – AMPT key

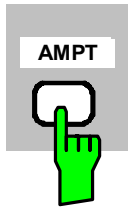

REF LEVEL

The *AMPT* key opens a submenu for level setting.

ADJUST  
REF LEVEL

The *REF LEVEL* softkey allows the reference level to be input in the currently active unit (dBm, dBµV, etc).

REF LEVEL  
OFFSET

IEC/IEEE bus command:            `DISP:WIND:TRAC:Y:RLEV -60dBm`

*ADJUST REF LVL* executes a routine for optimum adjustment of the reference level to the signal.

Y PER DIV

IEC/IEEE bus command:  
`[SENSe<1|2>:]CDPower:LEVel:ADJust`

REF VALUE  
POSITION

The *REF LEVEL OFFSET* softkey allows the arithmetic level offset to be entered. This offset is added to the measured level irrespective of the selected unit. The scaling of the Y axis is changed accordingly. The setting range is ±200 dB in 0.1 dB steps.

RF ATTEN  
MANUAL

IEC/IEEE bus command:  
`DISP:WIND:TRAC:Y:RLEV:OFFS -10dB`

RF ATTEN  
AUTO

*Y PER DIV* determines the grid spacing on the Y axis for all diagrams, where possible.

IEC/IEEE bus command:  
`DISPlay[:WINDow<1|2>]:TRACe<1..3>:Y[:SCALE]:PDIVision`

*REF VALUE POSITION* allows entry of the position of the reference value on the Y axis (0 – 100%).

IEC/IEEE bus command:  
`DISPlay[:WINDow<1|2>]:TRACe<1..3>:Y[:SCALE]:RPOsition`

The *RF ATTEN MANUAL* softkey allows the attenuation to be entered irrespective of the reference level.

The attenuation can be set in 10 dB steps between 0 and 70 dB (in 5 dB steps between 0 and 75 dB if option FSU-B25, *Electronic Attenuator*, is fitted). Other entries will be rounded to the next lower integer value.

If the defined reference level cannot be set for the specified RF attenuation, the reference level will be adjusted accordingly and the warning "Limit reached" will be output.

IEC/IEEE bus command:            `INP:ATT 40 DB`

The *RF ATTEN AUTO* softkey sets the RF attenuation automatically as a function of the selected reference level.

This ensures that the optimum RF attenuation desired by the user is always used.

*RF ATTEN AUTO* is the default setting.

IEC/IEEE bus command:            `INP:ATT:AUTO ON`

Marker Settings – MKR key

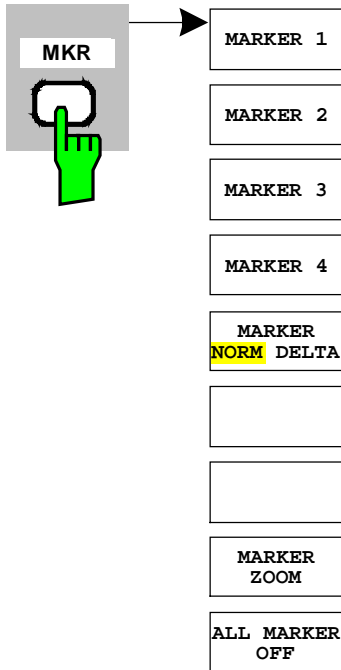

The *MARKER* key opens a submenu for the marker settings.

Markers are not available for the *RESULT SUMMARY* and *CHANNEL TABLE* displays. In all other displays, up to four markers can be activated, and they can be defined as a marker or delta marker by means of the *MARKER NORM/DELTA* softkey.

The *MARKER 1/2/3/4* softkey selects the corresponding marker and activates it.

*MARKER 1* is always the normal marker. After *MARKERS 2 to 4* have been switched on, they are delta markers that are referenced to *MARKER 1*. These markers can be converted into markers with absolute value displays by means of the *MARKER NORM DELTA* softkey. When *MARKER 1* is the active marker, pressing the *MARKER NORM DELTA* softkey switches on an additional delta marker.

Pressing the *MARKER 1* to *MARKER 4* softkey switches off the selected marker.

IEC/IEEE bus command:            `CALC:MARK ON;`  
                                          `CALC:MARK:X <value>;`  
                                          `CALC:MARK:Y?`  
                                          `CALC:DELT ON;`  
                                          `CALC:DELT:MODE ABS|REL`  
                                          `CALC:DELT:X <value>;`  
                                          `CALC:DELT:X:REL?`  
                                          `CALC:DELT:Y?`

The *MARKER ZOOM* softkey expands the area around the active marker. With the zoom function, more details of the measurement signal can be seen.

The softkey *MARKER ZOOM* can be selected only if at least one of the markers is activated.

If an instrument setting is changed after *MARKER ZOOM* is selected, the function is cancelled.

IEC/IEEE bus command:            `CALC:MARK1:FUNC:ZOOM`

The *ALL MARKER OFF* softkey switches off all markers (reference and delta markers). It also switches off all functions and displays that are associated with the markers/delta markers.

IEC/IEEE bus command:            `CALC:MARK:AOFF`

The parameters of an activated marker are output on top of the diagram:

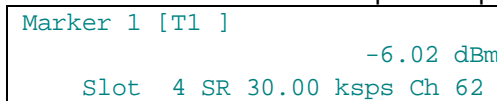

Fig. 6-36 Parameters of marker info field

In addition to the channel power, which is displayed relative to the value specified with *POWER REF TOT/CPICH*, the parameters are:

Slot 4: Slot number of the channel (unassigned codes have a timing offset of 0 chips referenced to the beginning of the frame)

SR 30 ksp/s: Symbol rate of the channel (for unassigned codes 7.5 ksp/s)

Ch 62: Number of the spreading code of the channel

## Changing Instrument Settings – MKR→ key

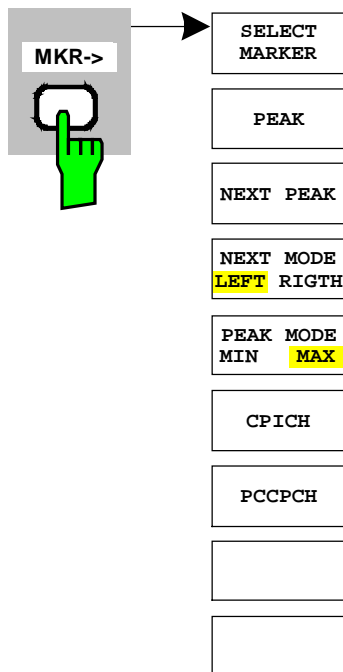

The *MKR→* key opens a submenu for marker functions:

The *SELECT MARKER* softkey activates numeric selection of the marker in the data entry field. Delta marker 1 is selected by entering 0.

IEC/IEEE bus command:      `CALC:MARK1 ON;`  
                                   `CALC:MARK1:X <value>;`  
                                   `CALC:MARK1:Y?`

The *PEAK* softkey sets the active marker or delta marker to the peak of the trace.

If no marker is active when the *MKR->* menu is called, *MARKER 1* is automatically switched on and the peak search is performed.

IEC/IEEE bus command:      `CALC:MARK:MAX`  
                                   `CALC:DELT:MAX`

The *NEXT PEAK* softkey sets the active marker/delta marker to the next lower peak value on the trace. The search direction is defined in the *NEXT MODE* submenu (see below).

IEC/IEEE bus command:      `CALC:MARK:MAX:NEXT`  
                                   `CALC:DELT:MAX:NEXT`  
                                           `CALC:MARK:MIN:NEXT`  
                                           `CALC:DELT:MIN:NEXT`

The *NEXT MODE LEFT/RIGHT* softkey defines the direction in which the next higher maximum or minimum is searched for. For *NEXT MODE LEFT/RIGHT*, the search is done to the left/right of the active marker.

IEC/IEEE bus command:      `CALC:MARK:MAX:LEFT`  
                                   `CALC:DELT:MAX:LEFT`  
                                   `CALC:MARK:MIN:LEFT`  
                                   `CALC:DELT:MIN:LEFT`  
                                   `CALC:MARK:MAX:RIGH`  
                                   `CALC:DELT:MAX:RIGH`  
                                   `CALC:MARK:MIN:RIGH`  
                                   `CALC:DELT:MIN:RIGH`

The *PEAK MODE MIN/MAX* softkey defines if the next minimum or maximum peak should be searched for. The parameter influences the behaviour of the *PEAK* and *NEXT PEAK* softkeys.

IEC/IEEE bus command:      --

The *MARKER -> CPICH* softkey sets the marker to the common pilot channel (code number 0 for spreading factor 256; corresponds to displayed code numbers 0 and 1 of the x axis).

IEC/IEEE bus commands:  
                                   `:CALCulate<1|2>:MARKer<1>:FUNction:CPICH`  
                                   `:CALCulate<1|2>:MARKer<1>:Y?`

The *MARKER -> PCCPCH* softkey sets the marker to the primary common control physical channel (code number 1 for spreading factor 256; corresponds to displayed code numbers 2 and 3 of the x axis).

IEC/IEEE bus commands:  
                                   `:CALCulate<1|2>:MARKer<1>:FUNction:PCCPch`  
                                   `:CALCulate<1|2>:MARKer<1>:Y?`

**Marker Functions – MKR *FCTN* key**

The *MKR FCTN* key is disabled for all measurements in the code domain power. For all other FS-K72/K74 measurements, the menu softkeys are described in the manual for the base unit.

**Bandwidth Setting – *BW* key**

The *BW* key is disabled for all measurements in the code domain power. For all other FS-K72/K74 measurements, the menu-specific softkeys are described in the manual for the base unit.

**Measurement Control – *SWEEP* key**

The menu of the *SWEEP* key contains options for switching between single measurement and continuous measurement and for controlling individual measurements. For measurements within the spectrum, the measurement time for a sweep can also be set. All menu-specific softkeys are described in the manual for the base unit.

**Measurement Selection – *MEAS* key**

The menu of the *MEAS* key contains all the FS-K72/K74 measurements that can be selected at a keystroke. The menu and its submenus are described in chapter 6.

**Trigger Settings – *TRIG* key**

The selectable trigger functions depend on the measurement selected. Code domain power measurements allow the free run mode as well as the frame trigger mode specified by the 3GPP standard. For all other measurements, the trigger modes are identical to those of the corresponding measurement in the base unit. The associated softkeys are described in the manual for the base unit.

Trace Settings – TRACE key

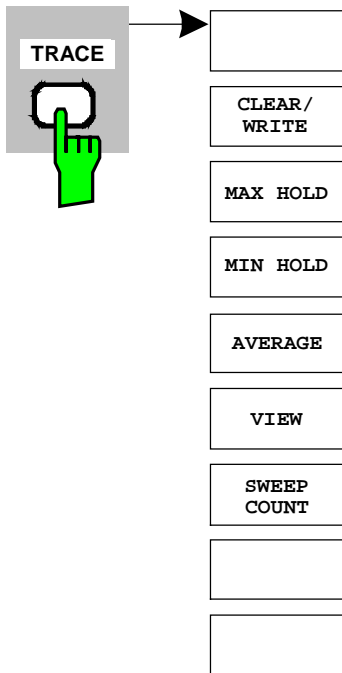

The *TRACE* key opens the following submenu:

The *CLEAR/WRITE* softkey activates the overwrite mode for the collected measured values, i.e. the trace is overwritten by each sweep.

In the *CLEAR/WRITE* display mode, all available detectors can be selected. In the default mode, the autopeak detector (setting *AUTO*) is selected.

Each time the *CLEAR/WRITE* softkey is actuated, the FSU clears the selected trace memory and restarts the measurement.

IEC/IEEE bus command      `DISP:WIND:TRAC:MODE WRIT`

The *MAX HOLD* softkey activates the max peak detector.

The FSU saves the sweep result in the trace memory only if the new value is greater than the previous one.

The signal spectrum is filled during each sweep until all signal components are detected in a kind of envelope.

Pressing the *MAX HOLD* softkey again clears the trace memory and restarts the max hold mode.

IEC/IEEE bus command      `DISP:WIND:TRAC:MODE MAXH`

The *MIN HOLD* softkey activates the min peak detector.

The FSU saves the sweep result in the trace memory only if the new value is greater than the previous one.

The signal spectrum is filled during each sweep until all signal components are detected in a kind of envelope.

Pressing the *MIN HOLD* softkey again clears the trace memory and restarts the max hold mode.

IEC/IEEE bus command      `DISP:WIND:TRAC:MODE MINH`

The *AVERAGE* softkey activates the trace averaging function. The average is formed over several sweeps. Averaging can be performed with any of the detectors available. If the detector is automatically selected by the FSU, the sample detector is used.

Averaging is restarted every time the *AVERAGE* softkey is pressed. The trace memory is always cleared.

IEC/IEEE bus command      `DISP:WIND:TRAC:MODE AVER`

The *VIEW* softkey freezes the current contents of the trace memory and displays them.

If a trace is frozen by *VIEW*, the instrument settings can be changed without the displayed trace being modified (exception: level display range and reference level, see below). The fact that the trace and the current instrument setting no longer agree is indicated by an enhancement label "\*" at the right edge of the grid.

If in the *VIEW* display mode the level display range (*RANGE*) or the reference level (*REF LEVEL*) is changed, the FSU automatically adapts the measured data to the changed display range. This allows an amplitude zoom to be carried out after the measurement in order to show details of the trace.

IEC/IEEE bus command      `DISP:WIND:TRAC:MODE VIEW`



The *SWEEP COUNT* softkey activates the entry of the number of sweeps used for averaging. The allowed range of values is 0 to 30000 and the following should be observed:

- Sweep Count = 0 means running averaging
- Sweep Count = 1 means no averaging being carried out
- Sweep Count > 1 means averaging over the selected number of sweeps; in the continuous sweep mode, averaging is performed until the set number of sweeps is attained and is then continued as running averaging.

The default setting is running averaging (Sweep Count = 0). The number of sweeps used for averaging is the same for all active traces in the selected diagram.

IEC/IEEE bus command                      SWE:COUN 64

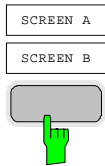

By using the softkeys *SCREEN A* or *SCREEN B*, the upper (A) or lower (B) part of the display screen can be selected. The trace statistic functions that are described above are applied only to the measurement results, which are displayed in the selected screen. A display of special interest is the *RESULT SUMMARY*. It is shown in the lower part (*SCREEN B*). If the trace statistic functions are applied to the result summary, the affected results are marked if they are an average result, a max hold or a min hold result.

- CLEAR/WRITE**    Displays the result value of the last sweep (<none>)
- MAX HOLD:**       Displays the maximum result values of a number of sweeps (<MAX>)
- MIN HOLD:**       Displays the minimum result value of a number of sweeps (<MIN>)
- AVERAGE:**       Displays the average result value of a number of sweeps (<AVG>)

The number of evaluated sweeps depends on the sweep count value. The figure below shows an example of the result summary display with applied sweep averaging. All averaged values are marked with *AVG*. Especially the resolution and accuracy of the trigger to frame value can be increased by using the trace average mode.

| Result Summary           |                  | SR 960 kbps    |                                |
|--------------------------|------------------|----------------|--------------------------------|
|                          |                  | Chan Code 64   |                                |
| CF 1.2 GHz      Slot # 0 |                  | Mapping I      |                                |
| <b>GLOBAL RESULTS</b>    |                  |                |                                |
|                          | Total Power      | AVG -15.47 dBm | Carr Freq Err AVG 72.40 Hz     |
| Ref                      | Chip Rate Err    | AVG -0.24 ppm  | Trg to Frame AVG 266.675562 μs |
| -6.20                    | IQ Offset        | AVG 0.22 %     | IQ Imbalance AVG 0.05 %        |
| dBm                      | Composite EVM    | AVG 2.78 %     | PkCDE(15ksps) AVG -53.67 dB    |
| Att* 0 dB                | Slot No          | 0              | No of Active Chan 6            |
| <b>CHANNEL RESULTS</b>   |                  |                |                                |
|                          | Symbol Rate      | 960.00 kbps    |                                |
| 1                        | Channel Code     | 1              | Channel Mapping I              |
| AVG                      | No of Pilot Bits | 0              |                                |
|                          | Chan Pwr Rel     | AVG -7.79 dB   | Chan Pwr Abs AVG -23.26 dBm    |
|                          | Symbol EVM       | AVG 2.34 % rms | Symbol EVM AVG 7.03 % Pk       |

SWP 8 of 20

Fig. 6-37 Result summary with applied average mode

**Display Lines – *LINES* key**

The *LINES* key is disabled for all measurements in the code domain power. For all other measurements, the menu settings are equivalent to those of the corresponding measurement in the base unit; the associated softkeys are described in the manual for the base unit.

**Settings of Measurement Screen – *DISP* key**

The menu of the *DISP* key contains softkeys for configuring the measurement screen. The menus and the softkey functions are described in the manual for the base unit.

**Storing and Loading of Unit Data – *FILE* key**

The *FILE* menu is identical to that of the base unit. All softkeys are described in the manual for the base unit.

All keys of the FSU front panel that are not specifically mentioned are identical to those of the base unit. The key functions and the softkeys are described in the manual for the base unit.

## 7 Remote Control Commands

The following chapter describes the remote control commands for the application firmware. An alphabetic list at the end of this chapter provides an overview of the commands.

The commands, which are also valid for the base unit in the signal analyzer mode as well as the system settings, are described in the operating manual for the analyzer.

### CALCulate:FEED - Subsystem

The CALCulate:FEED subsystem selects the evaluation method for the measured data. This corresponds to the result display selection in manual operation.

| COMMAND                                                                                                                                                                                                                    | PARAMETER | UNIT | COMMENT |
|----------------------------------------------------------------------------------------------------------------------------------------------------------------------------------------------------------------------------|-----------|------|---------|
| CALCulate<1 2><br>:FEED<br>:XPOWer<br>:CDP<br>[:ABSolute]<br>:RATio<br>:CDEP<br>:XTIME<br>:CDPower<br>:ERRor<br>:SUMMary<br>:CTABle<br>:PCDomain<br>:MACCuracy<br>:PVSLot<br>:BSTReam<br>:SYMBol<br>:CONStellation<br>:EVM |           |      |         |

**:CALCulate<1|2>:FEED <string>**

This command selects the measured data to be displayed.

**Parameter:** <string> ::= 'XPOW:CDP' |  
 'XPOW:CDP:ABS' |  
 'XPOW:CDP:RAT' |  
 'XPOW:CDEP'  
 'XTIM:CDP:MACCuracy' |  
 'XTIM:CDP:PVSLOT' |  
 'XTIM:CDP:PVSymbol' |  
 'XTIM:CDP:COMP:CONStellation'  
 'XTIM:CDP:BSTream' |  
 'XTIM:CDP:ERR:SUMM' |  
 'XTIM:CDP:ERR:CTABLE' |  
 'XTIM:CDP:ERR:PCDomain' |  
 'XTIM:CDP:SYMB:CONStellation' |  
 'XTIM:CDP:SYMB:EVM'

**Example:** " :CALC2:FEED `XTIM:CDP:MACCuracy` "

**Features:** \*RST value: 'XTIM:OFF' (vector signal analysis)  
 SCPI: conforming

**Note:** For code domain power (CDP) measurements, the display is always operated in the SPLIT SCREEN mode and the "display mode to measurement window" assignment is fixed. Therefore, the numeric suffix that is required or permitted is specified in brackets for each display mode.

The string parameters are defined as follows:

|                               |                                                                                                        |
|-------------------------------|--------------------------------------------------------------------------------------------------------|
| 'XPOW:CDP'                    | Result display of code domain power as bar graph [absolute scaling] (CALCulate<1>)                     |
| 'XPOW:CDP:ABS'                | Result display of code domain power ratio as bar graph [absolute scaling] (CALCulate<1>)               |
| 'XPOW:CDP:RAT'                | Result display of code domain power ratio as bar graph [relative scaling] (CALCulate<1>)               |
| 'XPOW:CDP:CDEP'               | Result display of code domain error power as bar graph (CALCulate<1>)                                  |
| 'XTIM:CDP:ERR:SUMM'           | Result display in tabular form (CALCulate2)                                                            |
| 'XTIM:CDP:ERR:CTABLE'         | Result display of channel assignment table (CALCulate<1>)                                              |
| 'XTIM:CDP:ERR:PCDomain'       | Result display of peak code domain error (CALCulate2)                                                  |
| 'XTIM:CDP:MACCuracy'          | Result display of composite EVM (error vector magnitude referenced to the overall signal) (CALCulate2) |
| 'XTIM:CDP:PVSymbol'           | Result display of power versus symbol (CALCulate2)                                                     |
| 'XTIM:CDP:COMP:CONStellation' | Result display of composite constellation (CALCulate2)                                                 |
| 'XTIM:CDP:PVSLOT'             | Result display of power versus slot (CALCulate2)                                                       |
| 'XTIM:CDP:BSTream'            | Result display of bit stream (CALCulate2)                                                              |
| 'XTIM:CDP:SYMB:CONStellation' | Result display of symbol constellation (CALCulate2)                                                    |
| 'XTIM:CDP:SYMB:EVM'           | Result display of symbol error vector magnitude (CALCulate2)                                           |

**CALCulate:LIMit – Subsystem**

**CALCulate:LIMit:ACPower Subsystem**

The CALCulate:LIMit:ACPower subsystem defines limit checking for adjacent channel power measurements.

| COMMAND                                                                                                                                                                                                  | PARAMETER                                                                                                                                                         | UNIT                                         | COMMENT |
|----------------------------------------------------------------------------------------------------------------------------------------------------------------------------------------------------------|-------------------------------------------------------------------------------------------------------------------------------------------------------------------|----------------------------------------------|---------|
| CALCulate<1 2><br>:LIMit1<br>:ACPower<br>[:STATe]<br>ACHannel<br>[:RELative]<br>:STATe<br>:ABSolute<br>:STATe<br>:RESult?<br>:ALTernate<1 2><br>[:RELative]<br>:STATe<br>:ABSolute<br>:STATe<br>:RESult? | < ON   OFF><br><br><value><br>< ON   OFF><br><value><br>< ON   OFF><br><value>,<value><br><br><value><br>< ON   OFF><br><value><br>< ON   OFF><br><value>,<value> | DB, DB<br><br>DBM, DBM<br><br><br><br>DB, DB |         |

**CALCulate<1|2>:LIMit1:ACPower[:STATe] ON | OFF**

This command switches on and off the limit check for adjacent channel power measurements in the selected measurement window. The commands CALCulate:LIMit:ACPower:ACHannel:STATe or CALCulate:LIMit:ACPower:ALTernate:STATe must be used in addition to specify whether the limit check is to be performed for the upper/lower adjacent channel or for the alternate adjacent channels.

**Example:** "CALC:LIM:ACP ON"

**Characteristics:** \*RST value: OFF  
SCPI: device-specific

**CALCulate<1|2>:LIMit1:ACPower:ACHannel[:RELative]** 0 to 100dB,  
0 to 100dB

This command defines the relative limit of the upper/lower adjacent channel for adjacent channel power measurements in the selected measurement window. The reference value for the relative limit value is the measured channel power.

It should be noted that the relative limit value has no effect on the limit check as soon as it is below the absolute limit value defined with CALCulate:LIMit:ACPower:ACHannel:ABSolute. This mechanism allows automatic checking of the absolute basic values of adjacent channel power as defined in mobile radio standards.

**Parameter:** The first numeric value is the limit for the upper (lower) adjacent channel. The second value is ignored but must be indicated for reasons of compatibility with the FSE family.

**Example:** "CALC:LIM:ACP:ACH 30DB, 30DB"  
'Sets the relative limit value in 'screen A for the power in the lower 'and upper adjacent channel to '30 dB below the channel power.

**Characteristics:** \*RST value: 0 dB  
SCPI: device-specific

**CALCulate<1|2>:LIMit1:ACPower:ACHannel[:RELative]:STATe** ON | OFF

This command activates the limit check for the relative limit value of the adjacent channel when adjacent channel power measurement is performed. Before the command, the limit check must be activated using `CALCulate:LIMit:ACPower:STATe ON`.

The result can be queried with `CALCulate:LIMit:ACPower:ACHannel:RESult?`. It should be noted that a complete measurement must be performed between switching on the limit check and the result query, since otherwise no valid results are available.

**Example:** `"CALC:LIM:ACP:ACH:REL:STAT ON"`  
'Switches on the check of the relative limit values for adjacent channels.

**Characteristics:** \*RST value: OFF  
SCPI: device-specific

**CALCulate<1|2>:LIMit1:ACPower:ACHannel:ABSolute** -200DBM to 200DBM,  
-200 to 200DBM

This command defines the absolute limit value for the lower/upper adjacent channel during adjacent-channel power measurement (Adjacent Channel Power) in the selected measurement window.

It should be noted that the absolute limit value has no effect on the limit check as soon as it is below the relative limit value defined with `CALCulate:LIMit:ACPower:ACHannel:RELative`. This mechanism allows automatic checking of the absolute basic values of adjacent channel power as defined in mobile radio standards.

**Parameter:** The first value is the limit for the lower and the upper adjacent channel. The second limit value is ignored but must be indicated for reasons of compatibility with the FSE family.

**Example:** `"CALC:LIM:ACP:ACH:ABS -35DBM, -35DBM"`  
'Sets the absolute limit value in 'screen A for the power in the lower 'and upper adjacent channel to '-35 dBm.

**Characteristics:** \*RST value: -200DBM  
SCPI: device-specific

**CALCulate<1|2>:LIMit1:ACPowEr:ACHannel:ABSolute:STATe ON | OFF**

This command activates the limit check for the adjacent channel when adjacent-channel power measurement (Adjacent Channel Power) is performed. Before the command, the limit check for the channel/adjacent-channel measurement must be globally switched on using `CALC:LIM:ACP ON`.

The result can be queried with `CALCulate:LIMit:ACPowEr:ACHannel:RESult?`. It should be noted that a complete measurement must be performed between switching on the limit check and the result query, since otherwise no valid results are available.

**Example:** `"CALC:LIM:ACP:ACH:ABS:STAT ON"`  
Switches on the check of absolute limit values for the adjacent channels.

**Characteristics:** \*RST value: OFF  
SCPI: device-specific

**CALCulate<1|2>:LIMit1:ACPowEr:ACHannel:RESult?**

This command queries the result of the limit check for the upper/lower adjacent channel in the selected measurement window when adjacent channel power measurement is performed. If the power measurement of the adjacent channel is switched off, the command produces a query error.

**Parameter:** The result is returned in the form `<result>`, `<result>` where `<result>` = PASSED | FAILED, and where the first returned value denotes the lower, the second denotes the upper adjacent channel.

**Example:** `"CALC:LIM:ACP:ACH:RES?"`  
Queries the limit check result in the adjacent channels Sets the relative limit value for the power in the lower and upper adjacent channel to 30 dB below the channel power.

**Characteristics:** \*RST value: --  
SCPI: device-specific

**CALCulate<1|2>:LIMit1:ACPowEr:ALTErnate<1|2>[:RELative] 0 to 100dB, 0 to 100dB**

This command defines the limit for the first/second alternate adjacent channel in the selected measurement window for adjacent channel power measurements. The reference value for the relative limit value is the measured channel power.

The numeric suffix after `ALTErnate<1|2>` denotes the first or the second alternate channel. It should be noted that the relative limit value has no effect on the limit check as soon as it is below the absolute limit defined with

`CALCulate:LIMit:ACPowEr:ALTErnate<1|2>:ABSolute`. This mechanism allows automatic checking of the absolute basic values of adjacent channel power as defined in mobile radio standards.

**Parameter:** The first value is the limit for the lower and the upper alternate adjacent channel. The second limit value is ignored but must be indicated for reasons of compatibility with the FSE family.

**Example:** `"CALC:LIM:ACP:ALT2 30DB, 30DB"`  
Sets the relative limit value in screen A for the power in the lower and upper alternate adjacent channel to 30 dB below the channel power.

**Characteristics:** \*RST value: 0dB  
SCPI: device-specific

**CALCulate<1|2>:LIMit1:ACPowEr:ALTErnatE<1|2>[:RELative]:STATe ON | OFF**

This command activates the limit check for the first/second alternate adjacent channel in the selected measurement window for adjacent channel power measurements. Before the command, the limit check must be activated using `CALCulate:LIMit:ACPowEr:STATe ON`.

The numeric suffix after `ALTErnatE<1|2>` denotes the first or the second alternate channel.

The result can be queried with `CALCulate:LIMit:ACPowEr:ALTErnatE<1|2>:RESult?`. It should be noted that a complete measurement must be performed between switching on the limit check and the result query, since otherwise no valid results are obtained.

**Example:** `"CALC:LIM:ACP:ACH:REL:STAT ON"`  
 'Switches on the check of the relative limit 'values for the alternate adjacent channels in 'screen A.

**Characteristics:** \*RST value: OFF  
 SCPI: device-specific

**CALCulate<1|2>:LIMit1:ACPowEr:ALTErnatE<1|2>:ABSolute -200DBM to 200DBM, -200DBM to .200DBM**

This command defines the absolute limit value for the lower/upper alternate adjacent channel power measurement (Adjacent Channel Power) in the selected measurement window.

The numeric suffix after `ALTErnatE<1|2>` denotes the first or the second alternate channel. The numeric suffixes <1 to 8> are irrelevant for this command.

It should be noted that the absolute limit value for the limit check has no effect as soon as it is below the relative limit value defined with `CALCulate:LIMit:ACPowEr:ALTErnatE<1|2>:RELative`. This mechanism allows automatic checking of the absolute basic values defined in mobile radio standards for the power in adjacent channels.

**Parameter:** The first value is the limit for the lower and the upper alternate adjacent channel. The second limit value is ignored but must be indicated for reasons of compatibility with the FSE family.

**Example:** `"CALC:LIM:ACP:ALT2:ABS -35DBM, -35DBM"`  
 'Sets the absolute limit value in 'screen A for the power in the lower 'and upper second alternate 'adjacent channel to -35 dBm.

**Characteristics:** \*RST value: -200DBM  
 SCPI: device-specific

**CALCulate<1|2>:LIMit1:ACPowEr:ALTErnatE<1|2>:ABSolute:STATe ON | OFF**

This command activates the limit check for the first/second alternate adjacent channel in the selected measurement window for adjacent channel power measurement (Adjacent Channel Power). Before the command, the limit check must be globally switched on for the channel/adjacent channel power with the command `CALCulate:LIMit:ACPowEr:STATe ON`.

The numeric suffix after `ALTErnatE<1|2>` denotes the first or the second alternate channel.

The result can be queried with `CALCulate:LIMit:ACPowEr:ALTErnatE<1|2>:RESult?`. It should be noted that a complete measurement must be performed between switching on the limit check and the result query, since otherwise no valid results are available.

**Example:** `"CALC:LIM:ACP:ACH:ABS:STAT ON"`  
 Switches on the check of absolute limit values for the alternative adjacent channels.

**Characteristics:** \*RST value: OFF  
 SCPI: device-specific



**CALCulate<1|2>:LIMit1:ACPpower:ALTErnate<1|2>:RESult?**

This command queries the result of the limit check for the first/second alternate adjacent channel in the selected measurement window for adjacent channel power measurements.

The numeric suffix after `ALTErnate<1|2>` denotes the first or the second alternate channel.

If the power measurement of the adjacent channel is switched off, the command produces a query error.

**Parameter:** The result is returned in the form `<result>, <result>` where `<result>` = PASSED | FAILED and where the first (second) returned value denotes the lower (upper) alternate adjacent channel.

**Example:** `"CALC:LIM:ACP:ALT:RES?"`  
Queries the limit check result in the second 'alternate adjacent channels in screen A

**Characteristics:** \*RST value: --  
SCPI: device-specific

**CALCulate:LIMit:SPECtrum Subsystem**

The CALCulate:LIMit:SPECtrum subsystem defines limit checking for spectral measurements with options WCDMA 3G FDD BTS (option FS-K72/K74)

| COMMAND                                                  | PARAMETER                                    | UNIT | COMMENT |
|----------------------------------------------------------|----------------------------------------------|------|---------|
| CALCulate:LIMit:ESpectrum<br>:MODE<br>:RESTore<br>:VALue | AUTO   MANual   USER<br><br>43   39   31   0 |      |         |

**:CALCulate:LIMit:ESpectrum:MODE AUTO | MANual | USER**

This command activates or deactivates automatic selection of the limit line in the spectrum emission mask measurement.

**Parameters:**

|        |                                                                                                                           |
|--------|---------------------------------------------------------------------------------------------------------------------------|
| AUTO   | The limit line is set as a function of the measured channel power.                                                        |
| MANUAL | One of the four predefined limit lines is set.<br>The selection is made with the command <code>CALC:LIM:ESP:VAL</code> .  |
| USER   | Query only; user-defined limit lines are active<br>(refer to description of limit lines in the manual for the base unit). |

**Example:** " :CALC:LIM:ESP:MODE AUTO "

**Features:**

|             |                 |
|-------------|-----------------|
| *RST value: | AUTO            |
| SCPI:       | device-specific |

**CALCulate:LIMit:ESpectrumRESTore**

This command restores the standard limit lines for the spectrum emission mask measurement. All modifications made to the standard limit lines are lost and the default setting valid upon delivery is restored.

The numeric suffixes <1|2> or <1 to 8> are irrelevant for this command.

**Example:** "CALC:LIM:ESP:REST" Sets the spectrum emission mask limit lines back to the default setting

**Characteristics:**

|             |                 |
|-------------|-----------------|
| *RST value: | --              |
| SCPI:       | device-specific |

**:CALCulate:LIMit:ESpectrum:VALue <numeric\_value>**

This command activates manual selection of the limit line. This means that one of the four possible limit lines is selected by specifying the expected power range as a value:

|                         |                      |                          |
|-------------------------|----------------------|--------------------------|
| Specified value in dBm: | Selected limit line: | Value returned on query: |
| Value $\geq$ 43         | $P \geq 43$          | 43                       |
| $39 \leq$ value < 43    | $39 \leq P < 43$     | 39                       |
| $31 \leq$ value < 39    | $31 \leq P < 39$     | 31                       |
| Value < 31              | $P < 31$             | 0                        |

**Example:** " :CALC:LIM:ESP:VALue 39 "

**Features:**

|             |                 |
|-------------|-----------------|
| *RST value: | 0               |
| SCPI:       | device-specific |

x  
**CALCulate:MARKer – Subsystem**

| COMMAND                                                                                                                      | PARAMETER                                                                                                                                                                                    | UNIT | COMMENT |
|------------------------------------------------------------------------------------------------------------------------------|----------------------------------------------------------------------------------------------------------------------------------------------------------------------------------------------|------|---------|
| :MARKer<1...4><br>:FUNction<br>:CPICh<br>:PCCPch<br>:WCDPower<br>[:BTS]<br>:RESult?<br><br>:POWer<br>:RESult<br>?<br><br>PHZ | PTOTal   FERRor   TFRame  <br>TOFFset   MACCuracy   PCDerror  <br>EVMRms   EVMPeak   CERRor  <br>CSLot   SRATe   CHANnel  <br>CDPabsolute   CDPRelative  <br>IQOOffset   IQIMbalance   MTYPE |      |         |
|                                                                                                                              | ACPower   CPOWer   MCACpower  <br>OBANdwidth   OBWidth                                                                                                                                       |      |         |
|                                                                                                                              | ON OFF                                                                                                                                                                                       |      |         |

**:CALCulate<1|2>:MARKer<1>:FUNction:CPICh**

This command sets the marker to channel 0.  
 This command is an <Event> and, therefore, has neither an \*RST value nor a query. Only the numeric suffix 1 is permissible in MARKer.  
 The numeric suffix in CALCulate that is required or permissible depends on the selected display mode for which the marker is to be valid and has to coincide with:

- CALCulate<1>     for CDP absolute and relative
- CALCulate2     for composite EVM, peak code domain error, power versus slot, bit stream, symbol constellation and EVM

**Example:**        ": CALC : MARK : FUNC : CPIC "

**Characteristics:** \*RST value:     \_  
 SCPI:             device-specific

**:CALCulate<1|2>:MARKer<1>:FUNction:PCCPch**

This command sets the marker to channel 1.  
 This command is an <Event> and, therefore, has neither an \*RST value nor a query. Only the numeric suffix 1 is permissible in MARKer.  
 The numeric suffix in CALCulate that is required or permissible depends on the selected display mode for which the marker is to be valid and has to coincide with:

- CALCulate<1>     for CDP absolute and relative
- CALCulate2     for composite EVM, peak code domain error, power versus slot, bit stream, symbol constellation and EVM

**Example:**        ": CALC : MARK : FUNC : PCCP "

**Characteristics:** \*RST value:     -  
 SCPI:             device-specific

**:CALCulate<1|2>:MARKer1:FUNCTION:POWER:RESult:PHZ ON|OFF**

This command switches the query response of the power measurement results in the indicated measurement window between output of absolute values (OFF) and output referred to the measurement bandwidth (ON). The measurement results are output with `CALCulate:MARKer:FUNCTION:POWER:RESult?`

**ON** Results output referred to measurement bandwidth.

**OFF** Results output in absolute values.

**Example:** "CALC:MARK:FUNC:POW:RES:PHZ ON"

**Characteristics:** \*RST value: OFF  
SCPI: device-specific

**Query of results:** `:CALCulate<1|2>:MARKer1:FUNCTION:POWER:RESult:PHZ?`

**Result:** `< 1 | 0 >`

**CALCulate<1|2>:MARKer<1...4>:FUNCTION:POWER:RESult? ACPower | CPOWer | MCACpower | OBANdwidth | OBWidth**

This command queries the result of the power measurement performed in the selected window. If necessary, the measurement is switched on prior to the query.

The channel spacings and channel bandwidths are configured in the `SENSe:POWER:ACHannel` subsystem.

To obtain a valid result, a complete sweep with synchronization to the end of the sweep must be performed before a query is output. Synchronization is possible only in the single-sweep mode.

**Parameters:**

**ACPower:** Adjacent-channel power measurement  
Results are output in the following sequence, separated by commas:

1. Power of transmission channel
2. Power of lower adjacent channel
3. Power of upper adjacent channel
4. Power of lower alternate channel 1
5. Power of upper alternate channel 1
6. Power of lower alternate channel 2
7. Power of upper alternate channel 2

The number of measured values returned depends on the number of adjacent/alternate channels selected with `SENSe:POWER:ACHannel:ACPairs`.

With logarithmic scaling (RANGE LOG), the power is output in the currently selected level unit; with linear scaling (RANGE LIN dB or LIN %), the power is output in W. If `SENSe:POWER:ACHannel:MODE REL` is selected, the adjacent/alternate-channel power is output in dB.

**CPOWer** Channel power measurement  
With logarithmic scaling (RANGE LOG), the channel power is output in the currently selected level unit; with linear scaling (RANGE LIN dB or LIN %), the channel power is output in W.

**MCACpower:** Channel/adjacent-channel power measurement with several carrier signals  
Results are output in the following sequence, separated by commas:

1. Power of carrier signal 1
2. Power of carrier signal 2
3. Power of carrier signal 3

4. Power of carrier signal 4
5. Total power of all carrier signals
6. Power of lower adjacent channel
7. Power of upper adjacent channel
8. Power of lower alternate channel 1
9. Power of upper alternate channel 1
10. Power of lower alternate channel 2
11. Power of upper alternate channel 2

The number of measured values returned depends on the number of carrier signals and adjacent/alternate channels selected with `SENSe:POWer:ACHannel:TXChannel:COUNT` and `SENSe:POWer:ACHannel:ACPairs`.

If only one carrier signal is measured, the total value of all carrier signals will not be output.

With logarithmic scaling (`RANGE LOG`), the power is output in dBm; with linear scaling (`RANGE LIN dB` or `LIN %`), the power is output in W.

If `SENSe:POWer:ACHannel:MODE REL` is selected, the adjacent/alternate-channel power is output in dB.

**OBANdwidth | OBWidth** Measurement of occupied bandwidth  
The occupied bandwidth in Hz is returned.

**Example:** `" :CALC:MARK:FUNC:WCDP:RES? ACP "`

**Characteristics:** \*RST value: -  
SCPI: device-specific

**:CALCulate<1>:MARKer<1>:FUNCTION:WCDPower[:BTS]:RESult?** PTOTAL | FERRor | TFRame | TOFFset | MACCuracy | PCDerror | EVMRms | EVMPeak | CERRor | CSLot | SRATe | CHANnel | CDPabsolute | CDPRelative | IQOFFset | IQIMbalance | MTYPE |

This command queries the measured and calculated results of the 3GPP FDD code domain power measurement.

|             |                            |             |                             |
|-------------|----------------------------|-------------|-----------------------------|
| PTOTAL      | total power                | FERRor      | frequency error in Hz       |
| TFRame      | trigger to frame           | TOFFset     | timing offset               |
| MACCuracy   | composite EVM              | PCDerror    | peak code domain error      |
| EVMRms      | error vector magnitude RMS | EVMPeak     | error vector magnitude peak |
| CERRor      | chip rate error            | CSLot       | channel slot number         |
| SRATe       | symbol rate                | CHANnel     | channel number              |
| CDPabsolute | channel power absolute     | CDPRelative | channel power relative      |
| IQOFFset    | I/Q offset                 | IQIMbalance | I/Q imbalance               |
| MTYPE       | modulation type            |             |                             |

**Example:** `" :CALC:MARK:FUNC:WCDP:RES? PTOT "`

**Characteristics:** \*RST value: -  
SCPI: device-specific

**CALCulate:PEAKsearch – Subsystem**

| COMMAND     | PARAMETER       | UNIT | COMMENT |
|-------------|-----------------|------|---------|
| :CALCulate  |                 |      |         |
| :PEAKsearch |                 |      |         |
| :MARGin     | <numeric_value> | [dB] |         |
| :SUBRanges  | <numeric_value> | --   |         |

**:CALCULATE<1|2>:PEAKsearch**

The limit mask - reduced by an overall margin - is checked against the trace. The fail positions are marked. Every value is added to a peak list, which can be opened and saved in ASCII format or read out via an IEC/IEEE command.

**Example:** " :CALC:PEAK "

**Characteristics:** \*RST value: ---  
SCPI: device-specific

**Query of results:** :CALCULATE<1|2>:PEAKsearch ?

**Result:** <-->

**:CALCULATE<1|2>:PEAKsearch:MARGin <value>**

This command defines an overall margin which is subtracted from the limit line to make the peak search more stronger. If the values of the trace are above the limit line minus margin value it will be marked in the peak list.

**Example:** " :CALC:PEAK:MARG 6 "

**Characteristics:** Range: -200 ... 200  
Unit: [dB]  
\*RST value: 6  
SCPI: device-specific

**Query of results:** :CALCULATE<1|2>:PEAKsearch:MARGin ?

**Result:** <value>

**:CALCULATE<1|2>:PEAKsearch:SUBRanges <value>**

The command defines how many peaks are searched for within one range. The ranges are:

- below -4 MHz from the carrier,
- above +4 MHz from carrier, and
- the area from -4 MHz to +4 MHz around the carrier.

**Example:** " :CALC:PEAK:SUBR 25 "

**Characteristics:** Range: 1 ... 50  
Unit: []  
\*RST value: 25  
SCPI: device-specific

**Query of results:** :CALCULATE<1|2>:PEAKsearch:SUBRanges ?

**Result:** <value>

**CALCulate:STATistics – Subsystem**

The CALCulate:STATistics subsystem controls the statistical measurement functions in the instrument. The measurement window cannot be selected with these functions. The numeric suffix in CALCulate is therefore ignored.

| COMMAND         | PARAMETER       | UNIT | COMMENT |
|-----------------|-----------------|------|---------|
| :CALCulate      |                 |      |         |
| :STATistics     |                 |      |         |
| :APD            |                 |      |         |
| [:STATe]        | <Boolean>       | --   |         |
| :CCDF           |                 |      |         |
| [:STATe]        | <Boolean>       | --   |         |
| :NSAMples       | <numeric_value> |      |         |
| :SCALe          |                 |      |         |
| :AUTO           | ONCE            |      |         |
| :X              |                 |      |         |
| :RLEVel         | <numeric_value> | dBm  |         |
| :RANGe          | <numeric_value> | dB   |         |
| :Y              |                 |      |         |
| :UPPer          | <numeric_value> |      |         |
| :LOWer          | <numeric_value> |      |         |
| :PRESet         |                 |      |         |
| [:DUMMy]        |                 |      |         |
| :RLEVel         |                 |      |         |
| :RESult<1...3>? |                 |      |         |

**:CALCulate:STATistics[:BTS]:CCDF[:STATe] ON | OFF**

This command switches on or off the measurement of the complementary cumulative distribution function (CCDF).

**Example:** "CALC:STAT:CCDF ON"

**Characteristics:** \*RST value: OFF  
 SCPI: device-specific

**:CALCulate:STATistics:NSAMples 100 to 32768**

This command sets the number of measurement points to be acquired for the statistical measurement functions

**Example:** "CALC:STAT:NSAM 5000"

**Characteristics:** \*RST value: 10000  
 SCPI: device-specific

**CALCulate:STATistics:PRESet**

This command resets the scaling of the X and Y axes in a statistical measurement. The following values are set:

X axis ref level: -20 dBm  
 X axis range APD: 100 dB  
 X axis range CCDF: 20 dB  
 Y axis upper limit: 1.0  
 Y axis lower limit: 1E-6

**Example:** "CALC:STAT:PRES" Resets the scaling for statistical functions

**Characteristics:** \*RST value: --  
 SCPI: device-specific

**CALCulate:STATistics:PRESet:RLEVel**

This command adjusts the reference level to get an optimized sensitivity. Only the reference level is changed all other setting parameters are kept.

**Example:** "CALC:STAT:PRES:RLEVel" Resets the scaling for statistical functions

**Characteristics:** \*RST value: --  
 SCPI: device-specific

**CALCulate:STATistics:SCALE:AUTO ONCE**

This command optimizes the level setting of the instrument depending on the measured peak power, in order to obtain maximum instrument sensitivity.

To obtain maximum resolution, the level range is set as a function of the measured spacing between peak power and the minimum power for the APD measurement and of the spacing between peak power and mean power for the CCDF measurement. In addition, the probability scale for the number of test points is adapted.

**Note:** *Subsequent commands have to be synchronized with \*WAI, \*OPC or \*OPC? to the end of the autorange process which would otherwise be aborted.*

**Example:** "CALC:STAT:SCAL:AUTO ONCE; \*WAI"  
 Adapts the level setting for statistical measurements.

**Characteristics:** \*RST value: --  
 SCPI: device-specific

**:CALCulate:STATistics:SCALE:Y:UPPer 1E-5 to 1.0**

This command defines the upper limit for the Y axis of the diagram in statistical measurements. Since probabilities are specified on the Y axis, the entered numerical values are dimensionless.

**Example:** "CALC:STAT:SCAL:Y:UPP 0.01"

**Characteristics:** \*RST value: 1.0  
 SCPI: device-specific

**:CALCulate:STATistics:SCALE:Y:LOWer 1E-6 to 0.1**

This command defines the lower limit for the Y axis of the diagram in statistical measurements. Since probabilities are specified on the Y axis, the entered numerical values are dimensionless.

**Example:** "CALC:STAT:SCAL:Y:LOW 0.001"

**Characteristics:** \*RST value: 1E-6  
 SCPI: device-specific



### CONFigure:WCDPower – Subsystem

This subsystem comprises the commands for configuring the code domain power measurements. Only the numeric suffix 1 is permissible in CONFigure.

| COMMAND                                                                                                                                                                                                          | PARAMETER                                                                                                                                                                                                                                | UNIT | COMMENT           |
|------------------------------------------------------------------------------------------------------------------------------------------------------------------------------------------------------------------|------------------------------------------------------------------------------------------------------------------------------------------------------------------------------------------------------------------------------------------|------|-------------------|
| CONFigure<br>:WCDPower<br>[:BTS]<br>:MEASurement<br><br>:AScale<br>:STATe<br>:CTABLE<br>[:STATe]<br>:SElect<br>:NAME<br>:DATA<br><br>:COMMent<br>:COPY<br>:DElete<br>:CATalog?<br>:RESTore<br>:MCARier<br>:STATe | POWer   ACLR   MCAClr   ESpectrum  <br>OBANdwidth   OBWidth   WCDPower  <br>CCDF<br><br>< Boolean ><br><br><Boolean><br><file_name><br><file_name><br>AUTO   <numeric_value>,<br>AUTO   <numeric_value>..<br><br><string><br><file_name> |      | Option FS-K72/K74 |

#### CONFigure<1>:WCDPower[:BTS]:MEASurement POWER | ACLR | MCAClr | ESpectrum | OBANdwidth | OBWidth | WCDPower | CCDF

This command selects the 3GPP FDD base station tests. The settings of the predefined measurements are described for the associated softkey in chapter 6.

|                   |                      |                                                                                                                                            |
|-------------------|----------------------|--------------------------------------------------------------------------------------------------------------------------------------------|
| <b>Parameter:</b> | POWER                | Channel power measurement (standard 3GPP WCDMA Forward) with predefined settings                                                           |
|                   | ACLR                 | Adjacent-channel power measurement (standard 3GPP WCDMA Forward) with predefined settings                                                  |
|                   | MCAClr               | This command selects the 3GPP FDD base station test for measurement of <b>multi carrier adjacent channel leakage power ratio</b> (MCACLR). |
|                   | ESpectrum            | Measurement of spectrum emission mask                                                                                                      |
|                   | OBANdwidth   OBWidth | Measurement of occupied power bandwidth                                                                                                    |
|                   | WCDPower             | Code domain power measurement. This selection has the same effect as command INSTRument:SElect WCDPower.                                   |
|                   | CCDF                 | Measurement of complementary cumulative distribution function                                                                              |

**Characteristics:** "CONF:WCDP:MEAS POW"

**Features:** \*RST value: POWER  
SCPI: device-specific

**:CONFigure:WCDPower[:BTS]:AScale:STATe ON | OFF**

Is available if multi carrier is switched ON. The autoscaling function automatically changes the level settings if the center frequency is changed to another carrier.

ON Changes the level settings, if the center frequency is changed to another carrier.

OFF Does not change the level settings, if the center frequency is changed to another carrier.

**Example:** " :CONF:WCDP:BTS:ASC:STAT ON "

**Characteristics:** \*RST value: ON  
SCPI: device-specific

**Query of results:** :CONFigure:WCDPower:BTS:AScale:STATe ?

**Result:** <1|0>

**CONFigure:WCDPower[:BTS]:CTABLE[:STATe] ON | OFF**

This command switches the channel table on or off. When switch-on takes place, the measured channel table is stored under the name RECENT and is switched on. After the RECENT channel table is switched on, another channel table can be selected with the command

CONF:WCDP:CTABLE:SELEct.

**Note:** *The RECENT channel table must always be switched on first with the command CONF:WCDP:CTAB:STAT and then the required channel table can be selected with the command CONF:WCDP:CTAB:SEL*

**Example:** " :CONF:WCDP:CTAB ON "

**Characteristics:** \*RST value: OFF  
SCPI: device-specific

**CONFigure:WCDPower[:BTS]:CTABLE:SELEct <string>**

This command selects a predefined channel table file. Before using this command, the RECENT channel table must be switched on first with the command CONF:WCDP:CTAB:STATe ON.

**Example:** " :CONF:WCDP:CTABLE ON "  
" :CONF:WCDP:CTAB:SEL 'CTAB\_1' "

**Characteristics:** \*RST value: "RECENT"  
SCPI: device-specific

**:CONFigure:WCDPower[:BTS]:CTABLE:NAME <file\_name>**

This command selects an existing channel table or creates the name of a new channel table.

**Example:** " :CONF:WCDP:CTAB:NAME 'NEW\_TAB' "

**Characteristics:** \*RST value: "RECENT"  
SCPI: device-specific

**:CONFigure:WCDPower[:BTS]:CTABLE:DATA**

2..9,0..511,0 | 1,<numeric\_value> | AUTO, 2 | 4 | 8 | 16,0 | 1,<numeric\_value>...

This command defines the values of the selected channel table.

Each line of the table consists of 8 values:

<code class>,<code number>,<use TFCI>,<timing offset | AUTO>,<pilot length>,<pich>,<status>,<CDP relative [dB]>....

Code class: 2 to 9  
 Code number: 0 to 511  
 Use TFCI: 0: not used, 1: used  
 Timing offset: 0 to 38400, for code class 9, the step width is 512; otherwise, 256  
 Pilot length: code class 9: 4  
 code class 8: 2, 4, 8  
 code class 7: 4, 8  
 code class 5/6: 8  
 code class 2/3/4 16

Channel Type: 0: *DPCH* **Dedicated Physical Channel of a standard WCDMA Frame**  
 1: *PICH* **Paging Indication Channel**  
 2: *SCCPCH* **Secondary Common Control Physical Channel**  
 3: *HS\_SCCH* **HSDPA: High Speed Shared Control Channel**  
 4: *HS\_PDSCH* **HSDPA: High Speed Physical Downlink Shared Channel**  
 5: *CHAN* **any other QPSK modulated channel without pilot symbols**

Status: 0: not active, 1: active

CDP relative: for setting commands any value, for query CDP relative value

Channels PICH, CPICH and PCCPCH may only be defined once. If channel CPICH or PCCPCH is missing in the command, it is automatically added at the end of the table.

Prior to this command, the name of the channel table has to be defined with the command  
 CONF : WCDP : CTAB : NAME.

**Example:** " : CONF : WCDP : CTAB : DATA 8,0,0,0,0,0,1,0.00,  
 8,1,0,0,0,0,1,0.00,7,1,0,256,8,0,1,0.00"  
 2 channels are defined: CPICH, PCCPCH and a channel in code class 7

**Characteristics:** \*RST value: -  
 SCPI: device-specific

**:CONFigure:WCDPower[:BTS]:CTABLE:COMMENT <string>**

This command defines a comment for the selected channel table

Prior to this command, the name of the channel table has to be defined with command CONF : WCDP : CTAB : NAME and the values of the table have to be defined with command CONF : WCDP : CTAB : DATA .

**Example:** " : CONF : WCDP : CTAB : COMM 'Comment for table 1' "

**Characteristics:** \*RST value: ""  
 SCPI: device-specific

**:CONFigure:WCDPower[:BTS]:CTABLE:COPY <file\_name>**

This command copies one channel table onto another one. The channel table to be copied is selected with command CONF : WCDP : CTAB : NAME.

The name of the channel table may contain a maximum of 8 characters. This command is an "event" which is why it is not assigned an \*RST value and has no query.

**Parameter:** <file\_name> ::= name of the new channel table

**Example:** " : CONF : WCDP : CTAB : COPY 'CTAB\_2' "

**Characteristics:** \*RST value: --  
 SCPI: device-specific

**:CONFigure:WCDPower[:BTS]:CTABLE:DELeTe**

This command deletes the selected channel table. The channel table to be deleted is selected with the command `CONF:WCDP:CTAB:NAME`.

**Example:**           " : CONF : WCDP : CTAB : DEL "

**Characteristics:** \*RST value:    --  
                  SCPI:            device-specific

This command is an "event" which is why it is not assigned an \*RST value and has no query.

**:CONFigure:WCDPower[:BTS]:CTABLE:CATalog?**

This command reads out the names of all channel tables stored on the hard disk.

Syntax of output format:

<Sum of file lengths of all subsequent files>,<free memory on hard disk>,  
<1st file name>,<1st file length>,<2nd file name>,<2nd file length>,...,<nth file name>,  
<nth file length>

**Example:**           " : CONF : WCDP : CTAB : CAT ? "

**Characteristics:** \*RST value:    --  
                  SCPI:            device-specific

**:CONFigure:WCDPower[:BTS]:MCARrier:STATe ON | OFF**

If multi carrier is switched ON, the adjust reference level procedure ensures that the settings of RF attenuation and reference level are optimally adjusted for measuring a multi carrier signal.

ON   Adjust reference level considering multi carrier conditions.

OFF  Adjust reference level considering single carrier conditions

**Example:**           " : CONF : WCDP : BTS : MCAR : STAT   ON  "

**Characteristics:** \*RST value:            OFF  
                  SCPI:                    device-specific

**Query of results:** : CONF : WCDP : BTS : MCARrier : STATe  ?

**Result:**           <1 | 0>

**DISPlay – Subsystem**

The DISPLay subsystem controls the selection and presentation of textual and graphic information as well as of measurement data on the display. The measurement windows are selected by WINDow1 (screen A) or WINDow2 (screen B) .

| COMMAND                             | PARAMETER     | UNIT | COMMENT |
|-------------------------------------|---------------|------|---------|
| :DISPlay<br>[:WINDow<1 2>]<br>:SIZE | LARGE   SMALL | --   |         |

**:DISPlay[:WINDow<1|2>]:SIZE LARGE | SMALL**

This command switches the diagram to full screen size.

LARGE full screen size.

SMALL small screen size of the ACLR diagramm.

**Example:** "DISP:WIND1:SIZE LARG"

**Characteristics:** \*RST value: SMALL  
SCPI: device-specific

**Query of results:** :DISPlay[:WINDow<1 | 2>]:SIZE?

**Result:** <LARGE | SMALL>

**FORMat – Subsystem****:FORMat:DEXPort:DSEParator POINT | COMMa**

This command to select between default separators '.' (decimal point) and ',' (comma) .

POINT                    peak list is separated by point '.'

COMMa                    peak list is separated by comma ','

**Example:**                    ":FORM:DEXP:DSEP POIN"

**Characteristics:**            Range:                    < POINT | COMMa >  
Unit:                        []  
\*RST value:                POINT  
SCPI:                        device-specific

**Query of results:**            :FORMat:DEXPort:DSEParator ?

**Result:**                      < POINT | COMMa >

**INSTrument – Subsystem**

**:INSTrument[:SElect]** SANalyzer | RECeiver | ADEMod | MSGM | CDPower | WCDPower | BWCDpower

This command switches between the operating modes by means of text parameters. Selection BWCDpower or WCDPower presets the instrument as described in Chapter 2, Section "Basic Settings in Code Domain Measurement Mode".

**Example:** " :INST BWCD "

**Characteristics:** \*RST value: SANalyzer  
SCPI: conforming

**MMEMory – Subsystem****:MMEMory:STORe1:FINal 'A:\final.dat'**

This command exports the peak list in ASCII format to a file. The complete output format is similar to the trace export. The peak values within the file are comma separated in the format:

```
. <1> <freq1>, <level1>, <delta level 1>, <1> <freq2>, <level2>, <delta level 2>, ... <1> <freq n>, <level n>, <delta level n>
```

**Example:**                   ":MMEM:STOR:FIN 'A:\final.dat'"

**Characteristics:**    \*RST value:        ---  
                          SCPI:                device-specific

**Query of results:**    ---

**Result File:**        <1>                []            - trace number is always 1  
                          <freq>            [Hz]           - frequency of the peak  
                          <level>           [dBm]          - absolute level of the peak  
                          <delta level>   [dB]           - distance to the limit line



**SENSe:CDPower – Subsystem**

This subsystem controls the parameters for the code domain mode. The numeric suffix in `SENSe<1|2>` is not significant in this subsystem.

| COMMAND                  | PARAMETER                              | UNIT | COMMENT           |
|--------------------------|----------------------------------------|------|-------------------|
| [SENSe<1 2>]<br>:CDPower |                                        |      | Option FS-K72/K74 |
| :ICTReshold              | <numeric_value>                        | dB   |                   |
| :SBANd                   | NORMal   INVerse                       |      |                   |
| :LEVel                   |                                        |      |                   |
| :ADJust                  |                                        |      |                   |
| :LCODE                   |                                        |      |                   |
| [:VALue]                 | <hex>                                  | --   |                   |
| :CODE                    | <numeric_value>                        | --   |                   |
| :SLOT                    | <numeric_value>                        | --   |                   |
| :SFACTOR                 | 4   8   16   32   64   128   256   512 | --   |                   |
| :NORMalize               | <Boolean>                              | --   |                   |
| :PCONtrol                | SLOT PILot                             | --   |                   |
| :QINVert                 | <Boolean>                              | --   |                   |
| :PREFERENCE              | TOTAL   CPICH                          | --   |                   |
| :STYPE                   | CPICH   SCHannel                       | --   |                   |
| :ANTenna                 | OFF   <numeric_value>                  | --   |                   |
| :PDIFf                   | ON   OFF                               | --   |                   |
| :IQLength                | <numeric_value>                        | --   |                   |
| :FRAMe                   |                                        | --   |                   |
| [:VALue]                 | <numeric_value>                        | --   |                   |

**:[SENSe:]CDPower:SFACTOR 4 | 8 | 16 | 32 | 64 | 128 | 256 | 512**

This command defines the spreading factor. The spreading factor is only significant for display mode PEAK CODE DOMAIN ERROR.

**Example:** " :SENS:CDP:SFACTOR 16 "

**Characteristics:** \*RST value: 512  
SCPI: device-specific

**:[SENSe:]CDPower:CODE 0 to 511**

This command sets the code number. The code number refers to code class 9 (spreading factor 512).

**Example:** " :SENS:CDP:CODE 30 "

**Characteristics:** \*RST value: 0  
SCPI: device-specific

**:[SENSe:]CDPower:NORMALize ON | OFF**

This command switches elimination of I/Q offset on or off.

**Example:** " :SENS:CDP:NORM OFF "

**Characteristics:** \*RST value: OFF  
SCPI: device-specific

**Mode:** WCDP

**[SENSe<1|2>:]CDPower:PCONtrol PILOt | SLOt**

**Example:** " :CDP:PCON SLOt " switch to power averaging from slot start to the end of the slot  
An enhanced channel search to consider the properties of compressed mode channels is used.

" :CDP:PCON PILOt " switch to power averaging from the pilot symbols of the previous slot number to the start of the pilots of the displayed slot number  
The channel search does only consider standart channels.

**Characteristics:** \*RST value: PILOt  
SCPI: device-specific

**Mode:** 3G FDD BTS

**:[SENSe:]CDPower:QINVert ON | OFF**

This command inverts the Q component of the signal.

**Example:** " :SENS:CDP:QINV ON "

**Characteristics:** \*RST value: OFF  
SCPI: device-specific

**Mode:** WCDP

**:[SENSe:]CDPower:SLOt 0 to 14**

This command sets the slot number of the common pilot channels (CPICH).

**Example:** " :SENS:CDP:SLOt 3 "

**Characteristics:** \*RST value: 0  
SCPI: device-specific

**:[SENSe:]CDPower:SBANd NORMal | INVers**

This command is for interchanging the left and the right sidebands.

**Example:** " :CDP:CDP:SBAN INV "

**Characteristics:** \*RST value: NORM  
SCPI: device-specific

**Mode:** WCDP

**:[SENSe:]CDPower:LCODE[:VALue] #H0 to #H1fff**

This command defines the scrambling code in hexadecimal format.

**Example:** " :CDP:LCOD #H2 "

**Characteristics:** \*RST value: 0  
SCPI: device-specific

**:[SENSe:]CDPower:ICTReshold** -100 dB to + 10 dB

This command sets the threshold value from which a channel is treated as active. The level entered refers to the total signal power.

**Example:** " :CDP:ICTR -10DB "

**Characteristics:** \*RST value: -60 dB  
SCPI: device-specific

**:[SENSe:]CDPower:PREference** TOTal | CPICH

This command switches between the use of total power or CPICH power as the reference for the relative CDP measurement values.

**Example:** " :SENS:CDP:PREF CPIC "

**Characteristics:** \*RST value: TOTal  
SCPI: device-specific

**:[SENSe<1|2>:]CDPower:STYPe** CPICH | SCHannel

This command selects the type of synchronization.

CPICH Synchronization to CPICH (default setting). For this type of synchronization, the CPICH must be present in the transmit signal.

SCH Synchronization without CPICH. This type of synchronization is required for test model 4 without CPICH.

**Example:** " :CDP:STYP SCH "

**Characteristics:** \*RST value: CPICH  
SCPI: device-specific

**:[SENSe<1|2>:]CDPower:ANTenna** OFF | 1 | 2

This command activates or deactivates the antenna diversity mode and selects the antenna to be used.

OFF The antenna diversity mode is switched off.

1 | 2 The antenna diversity mode is switched on, and the signal from antenna 1 or antenna 2 is used for CDP analysis.

**Example:** " :CDP:ANT 1 "

**Characteristics:** \*RST value: OFF  
SCPI: device-specific

**:[SENSe<1|2>:]CDPower:PDIFf** ON|OFF

This command activates or deactivates the slot power difference calculation of the POWER VERSUS SLOT display.

ON The slot power difference to the previous slot is displayed (POWER VS SLOT display).

OFF The slot power of each slot is displayed (POWER VS SLOT display).

**Example:** " :CDP:PDIF ON "

**Characteristics:** \*RST value: OFF  
SCPI: device-specific

**:[SENSe<1|2>:]CDPower:IQLength** <numeric value>

This command specifies the number of frames that are captured by one sweep.

Range: FSU / FSP-B70 (*free run*): <numeric value> [1 ... 2]  
FSU / FSP-B70 (*ext. trig*): <numeric value> [1 ... 3]  
FSQ: <numeric value> [1 ... 100]

Unit: []

Default: 1

**Example:** " :CDP:IQLength 3 "

**Characteristics:** \*RST value: 1  
SCPI: device-specific

**:[SENSe<1|2>:]CDPower:FRAMe[:VALue]** <numeric value>

Range: <numeric value> [0 ... CAPTURE\_LENGTH - 1]

Unit: []

Default: 0

**Example:** " :CDP:FRAMe 1 "

**Characteristics:** \*RST value: 0  
SCPI: device-specific



**:[SENSE<1|2>:]POWER:ACHannel:BANDwidth[:CHANnel] <value>**

This command sets the channel bandwidth of the radio communication system. The bandwidths of adjacent channels are not influenced by this modification.

**Example:** "POW:ACH:BWID:CHAN 3.84MHz"

**Characteristics:** Range: 100Hz ... 1GHz  
 Unit: [Hz]  
 \*RST value: 3.84 MHz  
 SCPI: device-specific

**Query of results:** :[SENSE<1|2>:]POWER:ACHannel:BANDwidth[:CHANnel]?

**Result:** <100Hz ... 1GHz>

**:[SENSE<1|2>:]POWER:ACHannel:BANDwidth:ACHannel <value>**

This command defines the channel bandwidth of the adjacent channel of the radio transmission system. If the bandwidth of the adjacent channel is changed, the bandwidths of all alternate adjacent channels are automatically set to the same value.

**Example:** "POW:ACH:BWID:ACH 3.84MHz"

**Characteristics:** Range: 100Hz ... 1GHz  
 Unit: [Hz]  
 \*RST value: 3.84 MHz  
 SCPI: device-specific

**Query of results:** :[SENSE<1|2>:]POWER:ACHannel:BANDwidth:ACHannel?

**Result:** <100Hz ... 1GHz>

**:[SENSE<1|2>:]POWER:ACHannel:BANDwidth:ALternate<1|2> <value>**

This command defines the channel bandwidth of the first/second alternate adjacent channel of the radio transmission system. If the channel bandwidth of alternate adjacent channel 1 is changed, the bandwidth of alternate adjacent channel 2 is automatically set to the same value.

**Example:** "POW:ACH:BWID:ALT1 3.84MHz"  
 "POW:ACH:BWID:ALT2 3.84MHz"

**Characteristics:** Range: 100Hz ... 1GHz  
 Unit: [Hz]  
 \*RST value: 3.84 MHz  
 SCPI: device-specific

**Query of results:** :[SENSE<1|2>:]POWER:ACHannel:BANDwidth:ALternate<1|2>?

**Result:** <100Hz ... 1GHz>

**:[SENSE<1|2>:] POWER:ACHannel:MODE ABSolute|RELative**

This command toggles between absolute and relative adjacent channel measurement. For the relative measurement the reference value is set to the currently measured channel power by command SENSE:POWER:ACHannel:REFERENCE:AUTO ONCE.

ABSolute absolute adjacent channel measurement.

RELative relative adjacent channel measurement.

**Example:** "POW:ACH:MODE ABS"

**Characteristics:** \*RST value: ABSolute  
SCPI: device-specific

**Query of results:** : [SENSe<1|2>:]POWER:ACHannel:MODE?

**Result:** < ABSolute | RELative >

#### :[SENSe<1|2>:]POWER:ACHannel:PRESet MCACpower

This command adjusts the frequency span, the measurement bandwidths and the detector as required for the number of channels, the channel bandwidths and the channel spacings selected in the active power measurement. If necessary, adjacent-channel power measurement is switched on prior to the adjustment. To obtain valid results, a complete sweep with synchronization to the end of the sweep must be performed after the adjustment. Synchronization is possible only in the single-sweep mode.

**Example:** "POW:ACH:PRES MCAC"

**Characteristics:** \*RST value: --  
SCPI: device-specific

#### :[SENSe<1|2>:]POWER:ACHannel:PRESet:RLEVEL

This command adapts the reference level to the measured channel power. This ensures, that the signal path of the instrument is not overloaded. Since the measurement bandwidth is significantly smaller than the signal bandwidth in channel power measurements, the signal path can be overloaded although the trace is still significantly below the reference level. If the measured channel power equals the reference level, the signal path is not overloaded.

**Example:** "POW:ACH:PRES:RLEV"

**Characteristics:** \*RST value: --  
SCPI: device-specific

#### :[SENSe<1|2>:]POWER:ACHannel:REference:TXChannel:AUTO MINimum|MAXimum|LHIGhest

This command activates the automatic selection of a transmission channel to be used as a reference channel in relative adjacent-channel power measurements. The transmission channel with the highest power, the transmission channel with the lowest power, or the transmission channel nearest to the adjacent channels can be defined as a reference channel. The command is available only for multicarrier channel and adjacent-channel power measurements.

**Example:** "POW:ACH:REF:TXCH:AUTO MAX"  
"POW:ACH:REF:TXCH:AUTO LHIG"

**Features:** Range: MINimum Transmission channel with the lowest power  
MAXimum Transmission channel with the highest power  
LHIGhest Lowermost transmission channel for the lower adjacent channels, uppermost transmission

channel

for the upper adjacent channels

Unit: [ ]  
\*RST value: ---  
SCPI: device-specific

**:[SENSE<1|2>:]POWer:ACHannel:REFErence:TXCHannel:MANual <value>**

This command selects a transmission channel to be used as a reference channel in relative adjacent-channel power measurements. The command is available only for multicarrier channel and adjacent-channel power measurements

**Example:** "POW:ACH:REF:TXCH:MAN 1"  
**Characteristics:** Range: <1 ... number of TX channels>  
 Unit: [ ]  
 \*RST value: 1  
 SCPI: device-specific

**:[SENSE<1|2>:]POWer:ACHannel:SPACing:CHANnel <value>**

This command defines the channel spacing for the carrier signals.

**Example:** "POW:ACH:SPAC:CHAN 5MHz"  
**Characteristics:** Range: 100Hz ... 1GHz  
 Unit: [Hz]  
 \*RST value: 5MHz  
 SCPI: device-specific  
**Query of results:** :[SENSE<1|2>:]POWer:ACHannel:SPACing:CHANnel?  
**Result:** <100Hz ... 1GHz>

**:[SENSE<1|2>:]POWer:ACHannel:SPACing[: ACHannel] <value>**

This command defines the channel spacing of the adjacent channel to the TX channel. At the same time, the spacing of alternate adjacent channels 1 and 2 is set to the double or triple of the entered value.

**Example:** "POW:ACH:SPAC:ACH 5MHz"  
**Characteristics:** Range: 100Hz ... 1GHz  
 Unit: [Hz]  
 \*RST value: 5MHz  
 SCPI: device-specific  
**Query of results:** :[SENSE<1|2>:]POWer:ACHannel:SPACing[:ACHannel]?  
**Result:** <100Hz ... 1GHz>

**:[SENSE<1|2>:]POWer:ACHannel:SPACing:ALTErnate<1|2> <value>**

This command defines the spacing between the first (ALTErnate1) or the second alternate adjacent channel (ALTErnate2) and the TX channel. If the spacing to the alternate adjacent channel ALTErnate1 is modified, the spacing to alternate adjacent channel 2 is set to 1.5 times the entered value.

**Example:** "POW:ACH:SPAC:ALT1 10MHz"  
 "POW:ACH:SPAC:ALT2 15MHz"  
**Characteristics:** Range: 100Hz ... 1GHz  
 Unit: [Hz]  
 \*RST value: 10MHz (for ALTErnate 1)  
 15MHz (for ALTErnate 2)  
 SCPI: device-specific  
**Query of results:** :[SENSE<1|2>:]POWer:ACHannel:SPACing:ALTErnate<1|2>?  
**Result:** <100Hz ... 1GHz>



**:[SENSe<1|2>:]POWer:ACHannel:TXCHannel:COUNT <value>**

This command selects the number of carrier signals. The command is available only for multicarrier channel and adjacent-channel leakage power measurements (CALC:MARK:FUNC:POW:SEL MCAC).

**Example:** "POW:ACH:TXCH:COUN 4"

**Characteristics:** Range: 1...12  
 Unit: [ ]  
 \*RST value: 4  
 SCPI: device-specific

**Query of results:** :[SENSe<1|2>:]POWer:ACHannel:TXCHannel:COUNT?

**Result:** <1...12>

**:[SENSe<1|2>:]POWer:HSPeed ON|OFF**

This command switches on or off the high-speed adjacent channel leakage power measurement. The measurement itself is performed in the time domain on the center frequencies of the individual channels. The command automatically switches to the time domain and back. A weighting filters with root raised cosine characteristic and 0.22 roll off is used for band limitation.

ON high-speed measurement with RRC filter in time domain.

OFF measurement with gaussian filters in frequency domain.

**Example:** "POW:HSP ON"

**Characteristics:** \*RST value: OFF  
 SCPI: device-specific

**Query of results:** :[SENSe<1|2>:]POWer:HSPeed ?

**Result:** <1|0>

**:[SENSe<1|2>:]POWer:NCORrection ON|OFF**

This command switches on or off the correction of the instrument inherent noise for ACLR measurement. On activating this function, a reference measurement of the instrument inherent noise is performed. The measured noise power is then subtracted from the power in the examined channel. The instrument inherent noise is then re-determined after any change of the center frequency, resolution bandwidth, sweep time and level setting by repeating the reference measurement in the new instrument setting.

ON inherent noise correction is switched on.

OFF inherent noise correction is switched off.

**Example:** "POW:NCOR ON"

**Characteristics:** \*RST value: OFF  
 SCPI: device-specific

**Query of results:** :[SENSe<1|2>:]POWer:NCORrection ?

**Result:** <1|0>

**SENSe:SWEep – Subsystem****:[SENSe<1|2>:]SWEep:TIME <value>**

This command defines the sweep time. If `SWEep:TIME` is directly programmed, automatic coupling to resolution bandwidth and video bandwidth is switched off.

**Example:** "SWE:TIME <value>"

**Characteristics:** Range: 0.005 ... 16000  
Unit: [s]  
\*RST value: 0.16  
SCPI: device-specific

**Query of results:** :[SENSe<1|2>:]SWEep:TIME ?

**Result:** <0.005 ... 16000>

**STATus-QUEStionable:SYNC Register**

This register contains information on the error situation in the code domain power analysis of the FS-K72/K74 option. It can be queried with the following commands:

| COMMAND                                                        | PARAMETER                          | UNIT     | COMMENT           |
|----------------------------------------------------------------|------------------------------------|----------|-------------------|
| STATus<br>:QUEStionable<br>:SYNC<br>:CONDition ?<br>[:EVENT] ? | <numeric_value><br><numeric_value> | []<br>[] | Option FS-K72/K74 |

**:STATUS:QUEStionable:SYNC:CONDition ?**

This command reads the information on the error situation in the code domain power analysis of the FS-K72 option.

**Example:** " :STATUS:QUEStionable:SYNC:CONDition ? "

**Characteristics:** \*RST value: OFF  
SCPI: device-specific

**Return value:** (see Table 7-1)

**:STATUS:QUEStionable:SYNC[:EVENT] ?**

This command reads the information on the error situation in the code domain power analysis of the FS-K72 option. The value can only be read once.

**Example:** " :STATUS:QUEStionable:SYNC[:EVENT] ? "

**Characteristics:** \*RST value: OFF  
SCPI: device-specific

**Return value:** (see Table 7-1)

Table 7-1: Definition of the error bits of the SYNC register

| Bit No. | Definition                                                                                                                                                                                                                                                                                                                                                                                                                                                                                                                                                                                                                                                                                                                        |
|---------|-----------------------------------------------------------------------------------------------------------------------------------------------------------------------------------------------------------------------------------------------------------------------------------------------------------------------------------------------------------------------------------------------------------------------------------------------------------------------------------------------------------------------------------------------------------------------------------------------------------------------------------------------------------------------------------------------------------------------------------|
| 0       | Not used in FS-K72/K74.                                                                                                                                                                                                                                                                                                                                                                                                                                                                                                                                                                                                                                                                                                           |
| 1       | <b>K72/K74 Frame Sync failed</b><br>This bit is set when synchronization is not possible within the application.<br>Possible reasons:<br>Incorrectly set frequency<br>Incorrectly set level<br>Incorrectly set scrambling code<br>Incorrectly set values for Q-INVERT or SIDE BAND INVERT<br>Invalid signal at input                                                                                                                                                                                                                                                                                                                                                                                                              |
| 2 to 4  | Not used in the FS-K72 application.                                                                                                                                                                                                                                                                                                                                                                                                                                                                                                                                                                                                                                                                                               |
| 5       | <b>K72/K74 Incorrect Pilot Symbol</b><br>This bit is set when one or more of the received pilot symbols are not equal to the specified pilot symbols of the 3GPP standard.<br>Possible reasons:<br>Incorrectly sent pilot symbols in the received frame.<br>Low signal to noise ratio (SNR) of the WCDMA signal.<br>One or more code channels has a significantly lower power level compared to the total power. The incorrect pilots are detected in these channels because of low channel SNR.<br>One or more channels are sent with high power ramping. In slots with low relative power to total power, the pilot symbols might be detected incorrectly (check the signal quality by using the symbol constellation display). |
| 6 to 14 | Not used in the FS-K72/K74 application.                                                                                                                                                                                                                                                                                                                                                                                                                                                                                                                                                                                                                                                                                           |
| 15      | This bit is always 0.                                                                                                                                                                                                                                                                                                                                                                                                                                                                                                                                                                                                                                                                                                             |

## TRACe – Subsystem

| COMMAND                    | PARAMETER                                                   | UNIT | COMMENT |
|----------------------------|-------------------------------------------------------------|------|---------|
| TRACe<br>:DATA?<br>[:DATA] | FINal<br>TRACE1   TRACE2  <br>ABITstream   PWCDp  <br>CWCDp |      |         |

**:TRACe1[:DATA]? FINal1**

This command returns the peak list. For each peak the following entries are given:

. <freq1>, <level1>, <delta level 1>, <freq2>, <level2>, <delta level 2>,  
... <freq n>, <level n>, <delta level n>

**Example:** " :TRACe1[:DATA]? FINal1 "

**Characteristics:** \*RST value: ---  
SCPI: device-specific

**Query of results:** :TRACe1[:DATA]? FINal1

**Result:** <freq> [Hz] - frequency of the peak  
<level>[dBm] - absolute level of the peak  
<delta level> [dB] - distance to the limit line

**:TRACe[:DATA] TRACE1 | TRACE2 | ABITstream | PWCDp | CWCDp |**

This command transfers trace data from the controller to the instrument; the query reads trace data from the instrument.

**Example:** " :TRAC TRACE1,"+A\$ (A\$: data list in current format)  
" :TRAC? TRACE1 "

**Characteristics:** \*RST value: -  
SCPI: conforming

TRACE1, TRACE2, CTABLE, PWCDp, CWCDp (K74) or ABITstream can be queried depending on the display mode.

*TRACE1**CODE PWR ABSOLUTE / RELATIVE, CHANNEL TABLE (TRACE1)*

Each channel is defined by the class, the channel number, the absolute level, the relative level and the timing offset. The class denotes the spreading factor of the channel.

Class 9 corresponds to the highest spreading factor (512, symbol rate 7.5 ksps), class 2 to the lowest admissible spreading factor (4, symbol rate 960 ksps).

Five values are transmitted for each channel.

<class>,<channel number>,<absolute level>,<relative level>,<timing offset>, .....

*CODE PWR ABSOLUTE / RELATIVE:* The channels are output in ascending order sorted by code number, i.e. in the same sequence they are displayed on screen.

*CHANNEL TABLE:* The channels are sorted by code class, i.e. the unassigned channels are transmitted last.

The units are: Absolute level dBm  
Relative level dB referenced to CPICH or total power  
Timing offset chips

The example shows the results of a query for three channels with the following configuration:

- 1<sup>st</sup> channel: spreading factor 512, channel number 7, timing offset 0
- 2<sup>nd</sup> channel: spreading factor 4, channel number 1, timing offset 256 chips
- 3<sup>rd</sup> channel: spreading factor 128, channel number 255, timing offset 2560 chips

This yields the following result: 9, 7, -40, -20, 0, 2, 1, -40, -20, 256, 7, 255, -40, -20, 2560  
 The channel order is the same as in the CDP diagram, i.e. it depends on their position in the code domain of spreading factor 512

*PWCDp* Can be set if CODE PWR ABSOLUTE / RELATIVE, CHANNEL TABLE is selected for trace 1. The pilot length is transmitted in addition to the values as transmitted for trace 1. The pilot length is specified in symbols. Six values are transmitted for each channel:  
 < class>,<channel number>,<absolute level>,<relative level>,<timing offset> or <l/Q-mapping>,<pilot length>,...

*CTABLE* Can be set if CODE PWR ABSOLUTE / RELATIVE, CHANNEL TABLE is selected for trace 1. The pilot length and the channel state (active, inactive) are transmitted in addition to the values transmitted for trace 1. The pilot length is specified in symbols. Seven values are transmitted for each channel:  
 < class>,<channel number>,<absolute level>,<relative level>,<timing offset>,<pilot length>,<active|inactive>...

*CWCDp* Can be set if CODE PWR ABSOLUTE / RELATIVE, CHANNEL TABLE is selected for trace 1. The pilot length, channel state, channel type, modulation type and a reserved value are transmitted in addition to the values transmitted for trace 1. For each channel, 10 values are transmitted  
 <code class>,<channel number>,<absolute level>,<relative level>,<timing offset>,<pilot length>,<active flag>,<channel type>,<modulation type>,<reserved>...  
 The channels are output in ascending order sorted by code number, i.e. in the same sequence they are displayed on screen.

| No. | Parameter          | Range         | Unit      | Explanation                                                                                                                                                                                    |
|-----|--------------------|---------------|-----------|------------------------------------------------------------------------------------------------------------------------------------------------------------------------------------------------|
| 1)  | <code class>       | {2 ... 9}     | [1]       | Code class of the channel.                                                                                                                                                                     |
| 2)  | <channel number>   | {0 ... 511}   | [1]       | Code number of the channel.                                                                                                                                                                    |
| 3)  | <absolute level>   | {-∞ ... ∞}    | [dBm]     | Absolute level of the code channel at the selected channel slot. (The channel slot can be marked by the SELECTED CPICH slot.)                                                                  |
| 4)  | < relative level > | {-∞ ... ∞}    | [dB]      | Relative level of the code channel at the selected channel slot referenced to CPICH or total power. (The channel slot can be marked by the SELECTED CPICH slot.)                               |
| 5)  | <timing offset>    | {0 ... 38400} | [chips]   | Timing offset of the code channel to the frame start. The value is measured in chips. The step width is 256 chips in the case of code class 2 to 8, and 512 chips in the case of code class 9. |
| 6)  | <pilot length>     | {0,2,4,8,16}  | [symbols] | Pilot length of the code channel. According to the 3GPP standard, the pilot length range depends on the code class.                                                                            |
| 7)  | <active flag>      | {0,1}         | [1]       | Flag to indicate whether a channel is active<br>0 - channel not active<br>1 - channel active                                                                                                   |
| 8)  | <channel type>     | {0 ... 9}     | [1]       | Channel type indication                                                                                                                                                                        |
|     |                    | 0 - DPCH      |           | <b>D</b> edicated <b>P</b> hysical <b>C</b> hannel of a standard frame                                                                                                                         |
|     |                    | 1 - PICH      |           | <b>P</b> aging <b>I</b> ndication <b>C</b> hannel                                                                                                                                              |
|     |                    | 2 - CPICH     |           | <b>C</b> ommon <b>P</b> ilot <b>C</b> hannel                                                                                                                                                   |

|     |                   |                 |                                                                                                                                                                     |
|-----|-------------------|-----------------|---------------------------------------------------------------------------------------------------------------------------------------------------------------------|
|     |                   | 3 - PSCH        | Primary <b>S</b> ynchronization <b>C</b> hannel                                                                                                                     |
|     |                   | 4 - SSCH        | Secondary <b>S</b> ynchronization <b>C</b> hannel                                                                                                                   |
|     |                   | 5 - PCCPCH      | Primary <b>C</b> ommon <b>C</b> ontrol <b>P</b> hysical <b>C</b> hannel                                                                                             |
|     |                   | 6 - SCCPCH      | Secondary <b>C</b> ommon <b>C</b> ontrol <b>P</b> hysical <b>C</b> hannel                                                                                           |
|     |                   | 7 - HS_SCCH     | HSDPA: <b>H</b> igh <b>S</b> peed <b>S</b> hared <b>C</b> ontrol <b>C</b> hannel                                                                                    |
|     |                   | 8 - HS_PDSCH    | HSDPA: <b>H</b> igh <b>S</b> peed <b>P</b> hysical <b>D</b> ownlink <b>S</b> hared <b>C</b> hannel                                                                  |
|     |                   | 9 - CHAN        | Channel without any pilot symbols (QPSK modulated)                                                                                                                  |
|     |                   | 10 - DPCH-CPRSD | <b>D</b> edicated <b>P</b> hysical <b>C</b> hannel of compressed mode                                                                                               |
| 9)  | <modulation type> | {2,4,15}        | [1] Modulation type of the code channel at the selected channel slot. (The channel slot can be marked by adjusting SELECT CPICH slot.)                              |
|     |                   | 2 - QPSK        | Modulation type QPSK.                                                                                                                                               |
|     |                   | 4 - 16QAM       | Modulation type 16QAM.                                                                                                                                              |
|     |                   | 15 - NONE       | There is no power in the selected channel slot [slot is switched OFF]. (According to 3GPP, the power of an HSDPA channel can be switched every 2 ms, i.e. 3 slots.) |
| 10) | <reserved>        | {0}             | [1] Reserved for future functionality.                                                                                                                              |

*ABITstream*

Can be set only if CALC2:FEED "XTIM:CDP:BStream" is selected (in the lower bit stream window). This command returns the bit streams of all 15 slots one after the other. The output format may be REAL, UINT or ASCII. The number of bits of a 16QAM-modulated channel is twice that of a QPSK-modulated channel.

The output format is equal to that of the ":TRACe1:DATA? TRACE2" command in case of an activated bitstream display. The only difference is the number of symbols which are evaluated. The ABITSTREAM command evaluates all symbols of one frame. One value is transferred per bit (range 0,1,). Each symbol contains of two (QPSK) or four (16QAM) consecutive bits. The number of symbols is not constant and may vary depending on the selected channel and its symbol modulation type. The bit stream may contain invalid (symbols without power).

If the analyzer is equipped with FS-K72 only, the values and numbers of the bits are as follows:

|                    |                                                                                                                                                                                                                             |
|--------------------|-----------------------------------------------------------------------------------------------------------------------------------------------------------------------------------------------------------------------------|
| Unit:              | []                                                                                                                                                                                                                          |
| Range:             | {0,1,6,9}                                                                                                                                                                                                                   |
| Bits per symbol:   | $N_{\text{BitPerSymb}} = 2$                                                                                                                                                                                                 |
| Number of symbols: | $N_{\text{Symb}} = 150 \cdot 2^{(8\text{-Code Class})}$                                                                                                                                                                     |
| Number of bits:    | $N_{\text{Bit}} = N_{\text{Symb}} \cdot N_{\text{BitPerSymb}}$                                                                                                                                                              |
| Format:            | Bit <sub>0</sub> , Bit <sub>01</sub> , Bit <sub>10</sub> , Bit <sub>11</sub> , Bit <sub>20</sub> , Bit <sub>21</sub> , ..., ,<br>Bit <sub>NSymb 0</sub> , Bit <sub>NSymb 1</sub>                                            |
| Explanation:       | 0 - Low state of a transmitted bit<br>1 - High state of a transmitted bit<br>6 - Bit of a symbol of a suppressed slot of a DPCH in Compressed Mode (DPCH-CPRSD)<br>9 - Bit of a suppressed symbol of a DPCH (e.g. TFCI off) |

If the analyzer is equipped additionally with FS-K74, the values and numbers of the bits are as follows:

|                       |                                                                                                       |
|-----------------------|-------------------------------------------------------------------------------------------------------|
| Unit:                 | []                                                                                                    |
| Range:                | {0,1,6,7,8,9}                                                                                         |
| Bits per symbol:      | $N_{\text{BitPerSymb}} = \{2,4\}$                                                                     |
| Max. bits per symbol: | $N_{\text{BitPerSymb\_MAX}} = \text{MAX} \{N_{\text{BitPerSymb}}(\text{slot})\}_{\text{slot}=1}^{15}$ |
| Symbols per slot:     | $N_{\text{Symb\_Slot}} = 10 \cdot 2^{(8\text{-Code Class})}$                                          |
| Symbols per frame:    | $N_{\text{Symb\_Frame}} = 15 \cdot N_{\text{Symb\_Slot}} = 150 \cdot 2^{(8\text{-Code Class})}$       |
| Number of bits:       | $N_{\text{Bit}} = N_{\text{Symb\_Frame}} \cdot N_{\text{BitPerSymb\_MAX}}$                            |

- Format (QPSK):  $Bit_{00}, Bit_{01}, Bit_{10}, Bit_{11}, Bit_{20}, Bit_{21}, \dots$ ,  
 $Bit_{NSymb\_Frame\ 0}, Bit_{NSymb\_Frame\ 1}$
- Format (16QAM):  $Bit_{00}, Bit_{01}, Bit_{02}, Bit_{03}, Bit_{10}, Bit_{11}, Bit_{12}, Bit_{13}, \dots$ ,  
 $Bit_{NSymb\_Frame\ 0}, Bit_{NSymb\_Frame\ 1}, Bit_{NSymb\_Frame\ 2},$   
 $Bit_{NSymb\_Frame\ 3}$
- Explanation:
- 0 - Low state of a transmitted bit
  - 1 - High state of a transmitted bit
  - 6 - Bit of a symbol of a suppressed slot of a DPCH in Compressed Mode (DPCH-CPRSD)
  - 7 - Bit of a switched-off symbol of an HS-PDSCH channel
  - 8 - Reserved value of a QPSK symbol bit in a frame which includes also 16QAM symbols.
  - 9 - Bit of a suppressed symbol of a DPCH (e.g. TFCI off)

The values 7 and 8 are only used in case of a varying modulation type of an HS-PDSCH channel. In this case the number of bits per symbol ( $N_{BitPerSymb}$ ) varies too. However, the length of the transmitted bit vector ( $N_{Bit}$ ) depends only of the maximum number of bits per symbol in that frame. That means, if the modulation type changes throughout the frame this will not influence the number of biots being transmitted.

**Example 1:** Some slots of the frame are 16QAM modulated, other are QPSK modulated and some are switched OFF (NONE).

If one or more slots of the frame are 16QAM modulated, 4 bits per symbol are transmitted. In any slot of the frame with QPSK modulation, the first two of the four bits are marked by the number 8 and the last two represent the transmitted QPSK symbol. If no power is transmitted in a slot, 4 entries per symbol of value 7 are transmitted.

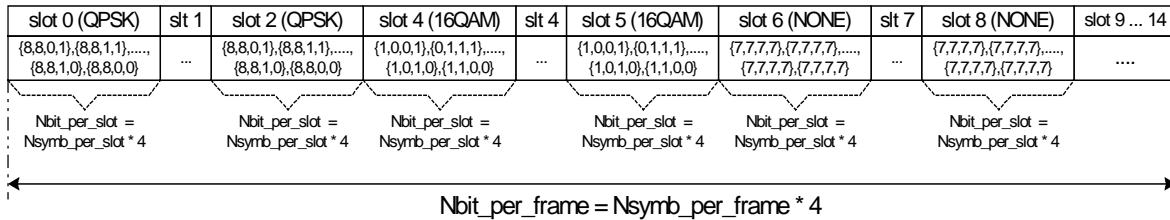

IEEE response:  $8,8,1,0, \dots, 8,8,0,1,1,1,0,1, \dots, 0,1,1,0,7,7,7,7, \dots, 7,7,7,7$

**Example 2:** Some slots of the frame are QPSK modulated and some are switched OFF.

If one or more slots of the frame are QPSK modulated and no slot is 16QAM modulated, 2 bits per symbol are transmitted. If no power is transmitted in a slot, 2 entries per symbol of value 7 are transmitted.

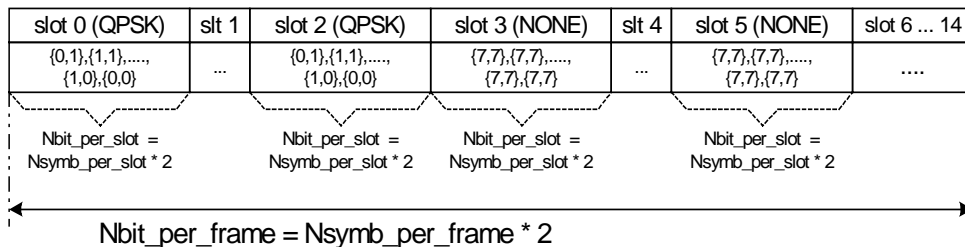

IEEE response:  $1,1,0,1, \dots, 0,1,1,0,7,7,7,7, \dots, 7,7,7,7$

**Third case:** Some slots of a DPCH are suppressed because of compressed mode transmission. The bits of the suppressed slots are marked by the digit '6'. In this case always 2 bits per symbol are transmitted.

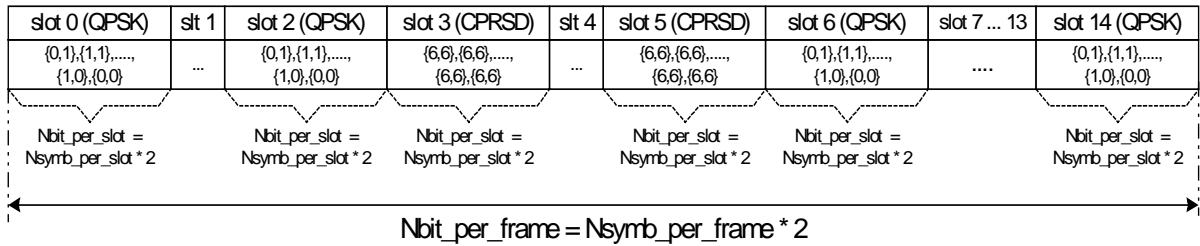

IEEE response: 1,1,0,1,.....,0,1,1,0,6,6,6,6,...6,6,6,6,1,1,0,1,.....,0,1,1,0

For TRACE1 or TRACE2, the following measured values are transferred depending on the display mode:

CODE DOMAIN ERROR POWER (TRACE1)

Output: Five values are transmitted for each code class 9 channel. The channels are sorted by code number

Format: <code class><sub>1</sub>, <code number><sub>1</sub>, <CDEP><sub>1</sub>, <channel flag><sub>1</sub>, <code class><sub>2</sub>, <code number><sub>2</sub>, <CDEP><sub>2</sub>, <channel flag><sub>2</sub>,

.....  
<code class><sub>512</sub>, <code number><sub>512</sub>, <CDEP><sub>512</sub>, <channel flag><sub>512</sub>

Unit: < [1] >, < [1] >, < [dB] >, < [1] >

Range: < 8 >, < 0...511 >, < -∞ ... ∞ >, < 0 ; 1 >

Quantity: 512

Explanation:

code class: [1] Highest code class of a downlink signal. It is always set to 9 (CC9).

code number: [1] Code number of the evaluated CC9 channel.

CDEP: [dB] Code domain error power value of the CC9 channel.

channel flag: [1] Denotes whether the CC9 channel belongs to an assigned code channel:

- Range:
- 0b00 0d0 - CC9 is inactive.
  - 0b01 0d1 - CC9 channel belongs to an active code channel.
  - 0b11 0d3 - CC9 channel belongs to an active code channel with sent pilot symbols incorrect.

POWER VS SLOT (TRACE2)

Sixteen (16) pairs of slots (slot number of CPICH) and level values (for 16 slots) are always transferred. <slot number>, <level value in dB>, <slot number>, <level value in dB>, ....

RESULT SUMMARY (TRACE2)

The results of the RESULT SUMMARY are output in the following order:

<composite EVM>, <peak CDE>, <carr freq error>, <chip rate error>, <total power>, <trg to frame>, <EVM peak channel>, <EVM mean channel>, <class>, <channel number>, <power abs. channel>, <power rel. channel>, <timing offset>, <l/Q offset>, <l/Q imbalance>

The units are:

EVM peak channel/mean channel, composite EVM, l/Q offset/imbalance: %

Peak CDE, total power and power abs. channel: dB

Power rel. Channel: dB referenced to CPICH or total power

Carr freq error: Hz

Chip rate error: ppm

Timing offset: chips

Trg to frame: μs



## COMPOSITE EVM PEAK and CODE DOMAIN ERR (TRACE2)

Fifteen (15) pairs of slot (slot number of CPICH) and values are always transferred.

COMPOSITE EVM: <slot number>, <value in %>, ....

PEAK CODE DOMAIN ERR: <slot number>, <level value in dB>, ....

## COMPOSITE CONSTELLATION

The real and the imaginary components of the chip constellation at the selected slot are transferred.

The values are normalized to the square root of the average power at the selected slot:

Output: List of I/Q values of all chips per slot  
 Format: Re<sub>1</sub>, Im<sub>1</sub>, Re<sub>2</sub>, Im<sub>2</sub>, ..., Re<sub>2560</sub>, Im<sub>2560</sub>  
 Unit: [1]  
 Quantity: 2560

## POWER VERSUS SYMBOL

The power of each symbol at the selected slot is transferred. The values indicate the difference to the reference power in dB. The number of the symbols depends on the spreading factor of the selected channel.

Output: List of symbol power relative to the reference power  
 Format: Val<sub>1</sub>, Val<sub>2</sub>, ..., Val<sub>NOF</sub>  
 Unit: [ dB]  
 Quantity:  $NOF_{Symbols} = 10 \cdot 2^{(8-Code Class)}$

## SYMBOL CONSTELLATION(TRACE2)

The real and the imaginary components are transferred as a pair:

<re 0>, <im 0>, <re 1>, <im 1>, ....., <re n>, <im n>

The number of level values depends on the spreading factor:

|                      |            |
|----------------------|------------|
| Spreading factor 512 | 5 values   |
| Spreading factor 256 | 10 values  |
| Spreading factor 128 | 20 values  |
| Spreading factor 64  | 40 values  |
| Spreading factor 32  | 80 values  |
| Spreading factor 16  | 160 values |
| Spreading factor 8   | 320 values |
| Spreading factor 4   | 640 value  |

## SYMBOL EVM (TRACE2)

The number of level values depends on the spreading factor:

|                      |            |
|----------------------|------------|
| Spreading factor 512 | 5 values   |
| Spreading factor 256 | 10 values  |
| Spreading factor 128 | 20 values  |
| Spreading factor 64  | 40 values  |
| Spreading factor 32  | 80 values  |
| Spreading factor 16  | 160 values |
| Spreading factor 8   | 320 values |
| Spreading factor 4   | 640 value  |

## BITSTREAM (TRACE2)

The bit stream of one slot is transferred. One value is transferred per bit (range 0, 1). Each symbol contains two consecutive bits in the case of a QPSK modulated slot and 4 consecutive bits in the case of a 16QAM modulated slot. The number of symbols is not constant and may vary for each sweep. Specific symbols in the bit stream may be invalid depending on the channel type and the bit rate (symbols without power). The assigned invalid bits are marked by one of the digits "6", "7" or "9".

If The analyzer is equipped with FS-K72 only, the values and numbers of the bits are as follows:

Unit: []

Range: {0,1,6,9}  
 Bits per symbol:  $N_{\text{BitPerSymb}} = 2$   
 Number of symbols:  $N_{\text{Symb}} = 10 \cdot 2^{(8\text{-Code Class})}$   
 Number of bits:  $N_{\text{Bit}} = N_{\text{Symb}} \cdot N_{\text{BitPerSymb}}$   
 Format:  $\text{Bit}_{00}, \text{Bit}_{01}, \text{Bit}_{10}, \text{Bit}_{11}, \text{Bit}_{20}, \text{Bit}_{21}, \dots$ ,  
 $\text{Bit}_{N_{\text{Symb}} 0}, \text{Bit}_{N_{\text{Symb}} 1}$   
 Explanation: 0 - Low state of a transmitted bit  
 1 - High state of a transmitted bit  
 6 - Bit of a symbol of a suppressed slot of a DPCH  
 in Compressed Mode (DPCH-CPRSD)  
 9 - Bit of a suppressed symbol of a DPCH  
 (e.g. TFCI off)

If the analyzer is equipped additionally with FS-K74, the values and numbers of the bits are as follows:

Unit: []  
 Range: {0,1,6,7,9}  
 Bits per symbol:  $N_{\text{BitPerSymb}} = \{2,4\}$   
 Symbols per slot:  $N_{\text{Symb\_Slot}} = 10 \cdot 2^{(8\text{-Code Class})}$   
 Number of bits:  $N_{\text{Bit}} = N_{\text{Symb\_Slot}} \cdot N_{\text{BitPerSymb}}$   
 Format (QPSK):  $\text{Bit}_{00}, \text{Bit}_{01}, \text{Bit}_{10}, \text{Bit}_{11}, \text{Bit}_{20}, \text{Bit}_{21}, \dots$ ,  
 $\text{Bit}_{N_{\text{Symb\_Frame}} 0}, \text{Bit}_{N_{\text{Symb\_Frame}} 1}$   
 Format (16QAM):  $\text{Bit}_{00}, \text{Bit}_{01}, \text{Bit}_{02}, \text{Bit}_{03}, \text{Bit}_{10}, \text{Bit}_{11}, \text{Bit}_{12}, \text{Bit}_{13}, \dots$ ,  
 $\text{Bit}_{N_{\text{Symb\_Frame}} 0}, \text{Bit}_{N_{\text{Symb\_Frame}} 1}, \text{Bit}_{N_{\text{Symb\_Frame}} 2},$   
 $\text{Bit}_{N_{\text{Symb\_Frame}} 3}$   
 Explanation: 0 - Low state of a transmitted bit  
 1 - High state of a transmitted bit  
 6 - Bit of a symbol of a suppressed slot of a DPCH in  
 Compressed Mode (DPCH-CPRSD)  
 7 - Bit of a switched-off symbol of an HS-PDSCH channel  
 9 - Bit of a suppressed symbol of a DPCH  
 (e.g. TFCI off)

**Table of Softkeys with Assignment of IEC/IEEE Commands**

|                   |                                                                                                                                                                                                                                                                                                                                                                                                                                                                                                                               |
|-------------------|-------------------------------------------------------------------------------------------------------------------------------------------------------------------------------------------------------------------------------------------------------------------------------------------------------------------------------------------------------------------------------------------------------------------------------------------------------------------------------------------------------------------------------|
| 3G FDD BS         | INSTRUMENT:SELect BWCDpower WCDPower                                                                                                                                                                                                                                                                                                                                                                                                                                                                                          |
| POWER             | :CONFigure<1>:WCDPower:MEASurement POWER<br>Query of results :CALCulate<1>:MARKer<1>:FUNction:POWER:RESult? CPower                                                                                                                                                                                                                                                                                                                                                                                                            |
| ADJUST REF LVL    | :[SENSe<1 2>:]POWER:ACHannel:PRESet:RLEVel                                                                                                                                                                                                                                                                                                                                                                                                                                                                                    |
| ACLR              | :CONFigure<1>:WCDPower:MEASurement ACLR<br>Query of results: :CALCulate<1>:MARKer<1>:FUNction:POWER:RESult? ACPower                                                                                                                                                                                                                                                                                                                                                                                                           |
| NO. OF ADJ CHAN   | :SENSe<1>:POWER:ACHannel:ACPairs 1<br>Query of results: :SENSe<1>:POWER:ACHannel:ACPairs?                                                                                                                                                                                                                                                                                                                                                                                                                                     |
| ADJUST SETTINGS   | :SENSe<1>:POWER:ACHannel:PRESet ACPower                                                                                                                                                                                                                                                                                                                                                                                                                                                                                       |
| SWEEP TIME        | :SENSe<1>:SWEep:TIME <value><br>Query of results: :SENSe<1>:SWEep:TIME ?<br>Result: <value> [sec]                                                                                                                                                                                                                                                                                                                                                                                                                             |
| NOISE CORR ON OFF | :SENSe<1>:POWER:NCORrection ON   OFF<br>Query of results: :SENSe<1>:POWER:NCORrection ?<br>Result: <0   1>                                                                                                                                                                                                                                                                                                                                                                                                                    |
| FAST ACLR ON OFF  | :SENSe<1>:POWER:HSPeed ON   OFF<br>Query of results: :SENSe<1>:POWER:HSPeed ?<br>Result: <0   1>                                                                                                                                                                                                                                                                                                                                                                                                                              |
| DIAGRAM FULL SIZE | ----                                                                                                                                                                                                                                                                                                                                                                                                                                                                                                                          |
| ADJUST REF LVL    | :SENSe<1>:POWER:ACHannel:PRESet:RLEVel                                                                                                                                                                                                                                                                                                                                                                                                                                                                                        |
| ACLR LIMIT CHECK  | :CALCulate<1>:LIMit1:ACPowEr ON   OFF<br>Query of results: :CALCulate<1>:LIMit1:ACPowEr ?<br>Result: <0   1><br><br>Query of results: :CALCulate<1>:LIMit1:ACPowEr:ACHannel:RESult?<br>Result: <PASSED <sub>Left SB</sub>   FAILED <sub>Left SB</sub> , PASSED <sub>Right SB</sub>   FAILED <sub>Right SB</sub> ><br><br>Query of results: :CALCulate<1>:LIMit1:ACPowEr:ALternate<1..2>:RESult?<br>Result: <PASSED <sub>Left SB</sub>   FAILED <sub>Left SB</sub> , PASSED <sub>Right SB</sub>   FAILED <sub>Right SB</sub> > |

|                    |
|--------------------|
| EDIT ACLR<br>LIMIT |
|--------------------|

```
:CALCulate<1>:LIMIT1:ACPower:ACHannel:[RELative] <Valleft,Valright>
Query of results: :CALCulate<1>:LIMIT1:ACPower:ACHannel:[RELative] ?
Result:           <Valleft,Valright> [dBc]

:CALCulate<1>:LIMIT1:ACPower:ACHannel:[RELative]:STATE ON
Query of results: :CALCulate<1>:LIMIT1:ACPower:ACHannel:[RELative]:STATE ?
Result:           <0 | 1>

:CALCulate<1>:LIMIT1:ACPower:ALternate<1..2>:[RELative] <Valleft,Valright>
Query of results: :CALCulate<1>:LIMIT1:ACPower:ACHannel:[RELative] ?
Result:           <Valleft,Valright> [dBc]

:CALCulate<1>:LIMIT1:ACPower:ALternate<1..2>:[RELative]:STATE ON
Query of results: :CALCulate<1>:LIMIT1:ACPower:ACHannel:[RELative]:STATE ?
Result:           <0 | 1>

:CALCulate<1>:LIMIT1:ACPower:ACHannel:ABSolute <Valleft,Valright>
Query of results: :CALCulate<1>:LIMIT1:ACPower:ACHannel:ABSolute ?
Result:           <Valleft,Valright> [dBm]

:CALCulate<1>:LIMIT1:ACPower:ACHannel:ABSolute:STATE ON
Query of results: :CALCulate<1>:LIMIT1:ACPower:ACHannel:ABSolute:STATE ?
Result:           <0 | 1>

:CALCulate<1>:LIMIT1:ACPower:ALternate<1..2>:ABSolute <Valleft,Valright>
Query of results: :CALCulate<1>:LIMIT1:ACPower:ACHannel:ABSolute ?
Result:           <Valleft,Valright> [dBm]

:CALCulate<1>:LIMIT1:ACPower:ALternate<1..2>:ABSolute:STATE ON
Query of results: :CALCulate<1>:LIMIT1:ACPower:ACHannel:ABSolute:STATE ?
Result:           <0 | 1>
```

|                      |
|----------------------|
| CHANNEL<br>BANDWIDTH |
|----------------------|

```
:SENSe<1>:POWER:ACHannel:BWIDth <Value> Hz|kHz|MHz|GHz
Query of results: :SENSe<1>:POWER:ACHannel:BWIDth ?
Result:           <Value> [Hz]
```

|                       |
|-----------------------|
| ADJ CHAN<br>BANDWIDTH |
|-----------------------|

```
:SENSe<1>:POWER:ACHannel:BWIDth:ACHannel <Value> Hz|kHz|MHz|GHz
Query of results: :SENSe<1>:POWER:ACHannel:BWIDth:ACHannel ?
Result:           <Value> [Hz]
```

```
:SENSe<1>:POWER:ACHannel:BWIDth:ALternate<1..2> <Value> Hz|kHz|MHz|GHz
Query of results: :SENSe<1>:POWER:ACHannel:BWIDth:ALternate<1..2> ?
Result:           <Value> [Hz]
```

|                     |
|---------------------|
| ADJ CHAN<br>SPACING |
|---------------------|

```
:SENSe<1>:POWER:ACHannel:SPACing[:ACHannel] <Value> Hz|kHz|MHz|GHz
Query of results: :SENSe<1>:POWER:ACHannel:SPACing[:ACHannel] ?
Result:           <Value> [Hz]
```

```
:SENSe<1>:POWER:ACHannel:SPACing:ALternate<1..2> <Value> Hz|kHz|MHz|GHz
Query of results: :SENSe<1>:POWER:ACHannel:SPACing:ALternate<1..2> ?
Result:           <Value> [Hz]
```

|                 |
|-----------------|
| ACLR<br>ABS REL |
|-----------------|

```
:SENSe<1>:POWER:ACHannel:MODE ABSolute | RELative
Query of results: :SENSe<1>:POWER:ACHannel:MODE ?
Result:           <ABS | REL>
```

|                  |
|------------------|
| CHAN PWR<br>/ Hz |
|------------------|

```
:CALCulate1:MARKer1:FUNCTION:POWER:RESult:PHZ ON|OFF
Query of results: :CALCulate1:MARKer1:FUNCTION:POWER:RESult:PHZ ?
Result:           <0 | 1>
```

| MULTI CARR<br>ACLR   | CONFigure<1>:WCDPower[:BTS]:MEASurement MCAClr                                                                                                                                                                                                                                                                                                                                                                                                                                                                                                                                                                                     |
|----------------------|------------------------------------------------------------------------------------------------------------------------------------------------------------------------------------------------------------------------------------------------------------------------------------------------------------------------------------------------------------------------------------------------------------------------------------------------------------------------------------------------------------------------------------------------------------------------------------------------------------------------------------|
| CP / ACP<br>CONFIG   | ---                                                                                                                                                                                                                                                                                                                                                                                                                                                                                                                                                                                                                                |
| NO. OF<br>ADJ CHAN   | :[SENSe<1 2>:]POWer:ACHannel:ACPairs <value><br>Query of results: :[SENSe<1 2>:]POWer:ACHannel:ACPairs?<br>Range: <0 1 2 3>                                                                                                                                                                                                                                                                                                                                                                                                                                                                                                        |
| NO. OF<br>TX CHAN    | :[SENSe<1 2>:]POWer:ACHannel:TXChannel:COUNT <value><br>Query of results: :[SENSe<1 2>:]POWer:ACHannel:TXChannel:COUNT?<br>Range: <1 ... 12>                                                                                                                                                                                                                                                                                                                                                                                                                                                                                       |
| CHANNEL<br>BANDWIDTH | :[SENSe<1 2>:]POWer:ACHannel:BANDwidth[:CHANnel] <value><br>:[SENSe<1 2>:]POWer:ACHannel:BANDwidth:ACHannel <value><br>:[SENSe<1 2>:]POWer:ACHannel:BANDwidth:ALternate<1 2> <value><br>Range: <100Hz ... 1GHz>                                                                                                                                                                                                                                                                                                                                                                                                                    |
| CHANNEL<br>SPACING   | :[SENSe<1 2>:]POWer:ACHannel:SPACing:CHANnel <value><br>:[SENSe<1 2>:]POWer:ACHannel:SPACing[: ACHannel] <value><br>:[SENSe<1 2>:]POWer:ACHannel:SPACing:ALternate<1 2> <value><br>Range: <100Hz ... 1GHz>                                                                                                                                                                                                                                                                                                                                                                                                                         |
| ACP REF<br>SETTINGS  | :[SENSe<1 2>:]POWer:ACHannel:REFerence:TXChannel:MANual <value><br>:[SENSe<1 2>:]POWer:ACHannel:REFerence:TXChannel:AUTO<br>MINimum MAXimum LHIGhest                                                                                                                                                                                                                                                                                                                                                                                                                                                                               |
| CP / ACP<br>ABS REL  | :[SENSe<1 2>:] POWer:ACHannel:MODE ABSolute RELative                                                                                                                                                                                                                                                                                                                                                                                                                                                                                                                                                                               |
| CHAN PWR<br>/ HZ     | :CALCulate<1 2>:MARKer1:FUNCTion:POWer:RESult:PHZ ON OFF                                                                                                                                                                                                                                                                                                                                                                                                                                                                                                                                                                           |
| ADJUST<br>SETTINGS   | :[SENSe<1 2>:]POWer:ACHannel:PRESet MCACpower                                                                                                                                                                                                                                                                                                                                                                                                                                                                                                                                                                                      |
| ACP LIMIT<br>CHECK   | CALCulate<1 2>:LIMit1:ACPoweR[:STATe] ON   OFF<br>CALCulate<1 2>:LIMit1:ACPoweR:ACHannel:RESult?<br>CALCulate<1 2>:LIMit1:ACPoweR:ALternate<1 2>:RESult?                                                                                                                                                                                                                                                                                                                                                                                                                                                                           |
| EDIT<br>ACP LIMIT    | CALCulate<1 2>:LIMit1:ACPoweR[:STATe] ON   OFF<br>CALCulate<1 2>:LIMit1:ACPoweR:ACHannel[:RELative] <value>,<value><br>CALCulate<1 2>:LIMit1:ACPoweR:ACHannel[:RELative]:STATe ON   OFF<br>CALCulate<1 2>:LIMit1:ACPoweR:ACHannel:ABSolute <value>,<value><br>CALCulate<1 2>:LIMit1:ACPoweR:ACHannel:ABSolute:STATe ON   OFF<br>CALCulate<1 2>:LIMit1:ACPoweR:ALternate<1 2>[:RELative] <value>,<value><br>CALCulate<1 2>:LIMit1:ACPoweR:ALternate<1 2>[:RELative]:STATe ON   OFF<br>CALCulate<1 2>:LIMit1:ACPoweR:ALternate<1 2>:ABSolute <value>,<value><br>CALCulate<1 2>:LIMit1:ACPoweR:ALternate<1 2>:ABSolute:STATe ON   OFF |
| SWEEP<br>TIME        | :[SENSe<1 2>:]SWEep:TIME <value>                                                                                                                                                                                                                                                                                                                                                                                                                                                                                                                                                                                                   |
| NOISE CORR<br>ON OFF | :[SENSe<1 2>:]POWer:NCORrection ON OFF                                                                                                                                                                                                                                                                                                                                                                                                                                                                                                                                                                                             |
| FAST ACP<br>ON OFF   | :[SENSe<1 2>:] POWer:HSPeEd ON OFF                                                                                                                                                                                                                                                                                                                                                                                                                                                                                                                                                                                                 |
| DIAGRAM<br>FULL SIZE | :DISPlay[:WINDow<1 2>]:SIZE LARGE   SMALL                                                                                                                                                                                                                                                                                                                                                                                                                                                                                                                                                                                          |
| ADJUST<br>REF LVL    | :[SENSe<1 2>:]POWer:ACHannel:PRESet:RLEVel                                                                                                                                                                                                                                                                                                                                                                                                                                                                                                                                                                                         |
| SPECTRUM<br>EM MASK  | :CONFigure:WCDPower:MEASurement ESpectrum<br>Query of results: :CALCulate<1>:LIMit<1>:FAIL?                                                                                                                                                                                                                                                                                                                                                                                                                                                                                                                                        |
| LIMIT LINE<br>AUTO   | :CALCulate<1>:LIMit<1>:ESpectrum:MODE AUTO                                                                                                                                                                                                                                                                                                                                                                                                                                                                                                                                                                                         |

LIMIT LINE  
MANUAL

```
:CALCulate<1>:LIMIT<1>:ESpectrum:MODE MANual
:CALCulate<1>:LIMIT<1>:ESpectrum:VALue <numeric_value>
```

LIMIT LINE  
USER

```
:CALCulate:LIMit<1>:NAME <string>
:CALCulate:LIMit<1>:UNIT DBM
:CALCulate:LIMit<1>:CONTRol[:DATA] <num_value>, <num_value>, ...
:CALCulate:LIMit<1>:CONTRol:DOMain FREQuency
:CALCulate:LIMit<1>:CONTRol:TRACe 1
:CALCulate:LIMit<1>:CONTRol:OFFset <num_value>
:CALCulate:LIMit<1>:CONTRol:MODE RELative

:CALCulate:LIMit<1>:UPPer[:DATA] <num_value>, <num_value>..
:CALCulate:LIMit<1>:UPPer:STATe ON | OFF
:CALCulate:LIMit<1>:UPPer:OFFset <num_value>
:CALCulate:LIMit<1>:UPPer:MARGin <num_value>
:CALCulate:LIMit<1>:UPPer:MODE ABSolute
:CALCulate:LIMit<1>:UPPer:SPACing LINear
```

**Note**

- 1 -If the y values are entered by means of the :CALCulate:LIMit<1>:LOWer[:DATA] command, the limit check result is "failed" if the limit line is underrange.
- 1 -If a user-defined limit line is activated, it has priority over limit lines selected with AUTO and MANUAL.

RESTORE  
STD LINES

```
:CALCulate:LIMit:ESpectrum:RESTore
```

PEAK  
SEARCH

```
:CALCULATE<1|2>:PEAKsearch
```

PEAKS  
PER RANGE

```
:CALCULATE<1|2>:PEAKsearch:SUBRanges <value>
Query of Results: :CALCULATE<1|2>:PEAKsearch:SUBRanges?
Result: <value>
Range: 1 ... 50
```

MARGIN

```
:CALCULATE<1|2>:PEAKsearch:MARGin <value>
Query of Results: :CALCULATE<1|2>:PEAKsearch:MARGin?
Result: <value>
Range: -200dB ... 200 dB
```

VIEW PEAK  
LIST

```
:TRACel[:DATA]? FINall
Result: <freq1>, <level1>, <delta level 1>,
<freq2>, <level2>, <delta level 2>,
...
<freq n>, <level n>, <delta level n>
```

SORT BY  
FREQUENCY

---

SORT BY  
DELTA LIM

---

ASCII FILE  
EXPORT

```
:MMEMory:STORel:FINal 'A:\final.dat'
```

DECIM SEP  
.

```
:FORMat:DEXPort:DSEPARATOR POINT | COMMA
```

PAGE  
UP

---

PAGE  
DOWN

---

ADJUST  
REF LVL

```
:[SENSe<1|2>:]POWer:ACHannel:PRESet:RLEVel
```

OCCUPIED  
BANDWIDTH

```
:CONFigure<1>:WCDPower:MEASurement OBANdwidth
Query of results: :CALCulate<1>:MARKer<1>:FUNCTion:POWer:RESult? OBANdwidth
```

% POWER  
BANDWIDTH

```
:SENSe<1>:POWer:BANDwidth <value> PCT
Query of results: :SENSe<1>:POWer:BANDwidth ?
Result: <value> [%]
```

|                     |                                                                                                                                                       |
|---------------------|-------------------------------------------------------------------------------------------------------------------------------------------------------|
| ADJUST<br>REF LVL   | :SENSE1:POWER:ACHannel:PRESet:RLEVel                                                                                                                  |
| ADJUST<br>SETTINGS  | :SENSE1:POWER:ACHannel:PRESet OBWidth                                                                                                                 |
| STATISTICS          | :CONFigure:WCDPower:MEASurement CCDF or<br>:CALCulate:STATistics[:BTS]:CCDF[:STATE] ON<br><br>Query of results: CALCulate:MARKer:X?                   |
| APD                 | :CALCulate1:STATistics:APD:STATE ON<br>Query of results: :CALCulate1:STATistics:APD:STATE?<br>Result: <0 1>                                           |
| CCDF                | :CALCulate1:STATistics:CCDF:STATE ON<br>Query of results: :CALCulate1:STATistics:CCDF:STATE?<br>Result: <0 1>                                         |
| PERCENT<br>MARKER   | :CALCulate<1>:MARKer1:Y:PERCent <value> PCT<br>Query of results: :CALCulate<1>:MARKer1:Y:PERCent ?<br>Result: <0..100> [%]                            |
| NO OF<br>SAMPLES    | :CALCulate<1>:STATistics:NSAMples <value><br>Query of results: :CALCulate<1>:STATistics:NSAMples ?<br>Result: <value>                                 |
| SCALING             | :CALCulate<1>:STATistics:NSAMples <value><br>Query of results: :CALCulate<1>:STATistics:NSAMples ?<br>Result: <value>                                 |
| X-AXIS<br>REF LEVEL | :CALCulate<1>:STATistics:SCALE:X:RLEVel <value> dBm<br>Query of results: :CALCulate<1>:STATistics:SCALE:X:RLEVel ?<br>Result: <value> [dBm]           |
| X-AXIS<br>RANGE     | :CALCulate<1>:STATistics:SCALE:X:RANGe <value> dBm<br>Query of results: :CALCulate<1>:STATistics:SCALE:X:RANGe ?<br>Result: <value> [dBm]             |
| Y-AXIS<br>MAX VALUE | :CALCulate<1>:STATistics:SCALE:Y:UPPer <value><br>Query of results: :CALCulate<1>:STATistics:SCALE:Y:UPPer?<br>Result: <value> Range: [1E-8...1]      |
| Y-AXIS<br>MIN VALUE | :CALCulate<1>:STATistics:SCALE:Y:LOWer <value><br>Query of results: :CALCulate<1>:STATistics:SCALE:Y:LOWer ?<br>Result: <value> Range: [1E-9...0.1]   |
| ADJUST<br>SETTINGS  | :CALCulate<1>:STATistics:SCALE:AUTO ONCE                                                                                                              |
| DEFAULT<br>SETTINGS | :CALCulate<1>:STATistics:PRESet                                                                                                                       |
| ADJUST<br>REF LVL   | :CALCulate<1>:STATistics:PRESet:RLEVel                                                                                                                |
| ADJUST<br>SETTINGS  | :CALCulate<1>:STATistics:SCALE:AUTO ONCE                                                                                                              |
| CONT<br>MEAS        | :INITiate<1>:CONTInuous ON<br>Query of results: :INITiate<1>:CONTInuous ?<br>Result: <1   0>                                                          |
| SINGLE<br>MEAS      | :INITiate<1>:IMMediate<br>:INITiate<1>:CONTInuous OFF<br>Query of results: :INITiate<1>:CONTInuous ?<br>Result: <0   1><br><br>:INITiate<1>:IMMediate |

|                         |                                                                                                                                                                                                                                                                                                                                                                                                                                                                                                  |
|-------------------------|--------------------------------------------------------------------------------------------------------------------------------------------------------------------------------------------------------------------------------------------------------------------------------------------------------------------------------------------------------------------------------------------------------------------------------------------------------------------------------------------------|
| CODE DOM<br>POWER       | <pre> :INSTRument&lt;1&gt;[:SElect] WCDPower or :CONFigure:WCDPower:MEASurement WCDPower  Query of results: :TRACe:DATA? TRACE1   TRACE2   ABITstream   PWCDp   CTABle   CWCDp  or :CALCulate&lt;1 2&gt;:MARKer&lt;1&gt;:FUNctIon:WCDPower:RESult? PTOTal   FERRor   TFRame   TOFFset   MACCuracy   PCDError   EVMRms   EVMPeak   CERror   CSLot   SRATe   CHANnel   CDPabsolute   CDPRelative   IQOFFset   IQIMbalance   MTYPE    or marker function (in marker submenu)                 </pre> |
| CHAN CONF               | --                                                                                                                                                                                                                                                                                                                                                                                                                                                                                               |
| CODE CHAN<br>AUTOSEARCH | :CONFigure:WCDPower[:BTS]:CTABle[:STATe] OFF                                                                                                                                                                                                                                                                                                                                                                                                                                                     |
| CODE CHAN<br>PREDEFINED | :CONFigure:WCDPower[:BTS]:CTABle[:STATe] ON<br>:CONFigure:WCDPower[:BTS]:CTABle:SElect <channel table name>                                                                                                                                                                                                                                                                                                                                                                                      |
| EDIT CHAN<br>CONF TABLE |                                                                                                                                                                                                                                                                                                                                                                                                                                                                                                  |
| CHAN TABLE<br>HEADER    | :CONFigure:WCDPower[:BTS]:CTABle:NAME "channel table name"<br>:CONFigure:WCDPower[:BTS]:CTABle:COMMENT "Comment for new table"                                                                                                                                                                                                                                                                                                                                                                   |
| CHAN TABLE<br>VALUES    | :CONFigure:WCDPower[:BTS]:CTABle:NAME "channel table name"<br>:CONFigure:WCDPower[:BTS]:CTABle:DATA <numeric_value>                                                                                                                                                                                                                                                                                                                                                                              |
| ADD<br>SPECIAL          | --                                                                                                                                                                                                                                                                                                                                                                                                                                                                                               |
| INSERT<br>LINE          | --                                                                                                                                                                                                                                                                                                                                                                                                                                                                                               |
| DELETE<br>LINE          | --                                                                                                                                                                                                                                                                                                                                                                                                                                                                                               |
| MEAS CHAN<br>CONF TABLE | --                                                                                                                                                                                                                                                                                                                                                                                                                                                                                               |
| SAVE TABLE              | -- (automatic if using remote control)                                                                                                                                                                                                                                                                                                                                                                                                                                                           |
| SORT TABLE              | --                                                                                                                                                                                                                                                                                                                                                                                                                                                                                               |
| NEW CHAN<br>CONF TABLE  | please refer to EDIT CHAN CONF TABLE                                                                                                                                                                                                                                                                                                                                                                                                                                                             |
| DEL CHAN<br>CONF TABLE  | :CONFigure:WCDPower[:BTS]:CTABle:NAME "channel table name"<br>:CONFigure:WCDPower[:BTS]:CTABle:DELeTe                                                                                                                                                                                                                                                                                                                                                                                            |
| COPY CHAN<br>CONF TABLE | :CONFigure:WCDPower[:BTS]:CTABle:NAME "channel table name"<br>:CONFigure:WCDPower[:BTS]:CTABle:COpy "new channel table name"                                                                                                                                                                                                                                                                                                                                                                     |
| SETTINGS                | --                                                                                                                                                                                                                                                                                                                                                                                                                                                                                               |
| SCRAMBLING<br>CODE      | :[SENSe:]CDPower:LCODE[:VALue] #H0 ... #H5fff<hex>                                                                                                                                                                                                                                                                                                                                                                                                                                               |
| INACT CHAN<br>THRESH    | :[SENSe:]CDPower:ICTReshold -50 dB ... +10 dB                                                                                                                                                                                                                                                                                                                                                                                                                                                    |



|                        |                                                                                                                                                                                                                                                                             |
|------------------------|-----------------------------------------------------------------------------------------------------------------------------------------------------------------------------------------------------------------------------------------------------------------------------|
| CODE PWR<br>ABS REL    | <p>Abs. scaling: :CALCulate&lt;1&gt;:FEED "XPOWER:CDP"<br/>:CALCulate&lt;1&gt;:FEED "XPOWER:CDP:ABSolute"</p> <p>Rel. scaling: :CALCulate&lt;1&gt;:FEED "XPOWER:CDP:RATio"</p>                                                                                              |
| POWER REF<br>TOT CPICH | : [SENSe:]CDPower:PREference TOTAL   CPICH                                                                                                                                                                                                                                  |
| COMP MODE<br>ON OFF    | <p>[:SENSe&lt;1&gt;]:CDPower:PCONtrol SLOT PIlot</p> <p>Query of results: [:SENSe&lt;1&gt;]:CDPower:PCONtrol ?</p> <p>Result: &lt;1 0&gt;</p>                                                                                                                               |
| SYNC TYPE<br>CPICH SCH | : [SENSe:]CDPower:STYPe CPICHh   SCHannel                                                                                                                                                                                                                                   |
| ANT DIV<br>ON OFF      | : [SENSe:]CDPower:ANTenna OFF   1   2                                                                                                                                                                                                                                       |
| ANT NO.<br>1 2         | : [SENSe:]CDPower:ANTenna OFF   1   2                                                                                                                                                                                                                                       |
| POWER DIFF<br>ON OFF   | <p>: [SENSe&lt;1 2&gt;:]CDPower:PDIFf ON OFF</p> <p>Query of results: [:SENSe&lt;1 2&gt;:]CDPower:PDIFf ?</p> <p>Result: &lt;1 0&gt;</p> <p>---</p>                                                                                                                         |
| MULTI FRM<br>CAPTURE   | ---                                                                                                                                                                                                                                                                         |
| CAPTURE<br>LENGTH      | <p>: [SENSe:]CDPower:IQLength &lt;numeric value&gt;</p> <p>Range: FSU / FSP-B70 (free run): &lt;numeric value&gt; [1 ... 2]<br/>FSU / FSP-B70 (ext. trig): &lt;numeric value&gt; [1 ... 3]<br/>FSQ: &lt;numeric value&gt; [1 ... 100]</p> <p>Unit: []</p> <p>Default: 1</p> |
| FRAME TO<br>ANALYZE    | <p>: [SENSe:]CDPower:FRAME[:VALue] &lt;numeric value&gt;</p> <p>This command selects one frame of the captured data, which is evaluated.</p> <p>Range: &lt;numeric value&gt; [0 ... CAPTURE_LENGTH - 1]</p> <p>Unit: []</p> <p>Default: 0</p>                               |
| MULT CARR<br>ON OFF    | : CONFigure:WCDPower[:BTS]:MCARier:STATE ON   OFF                                                                                                                                                                                                                           |
| AUTO SCALE<br>ON OFF   | : CONFigure:WCDPower[:BTS]:ASCale:STATE ON   OFF                                                                                                                                                                                                                            |
| INVERT Q<br>ON OFF     | : [SENSe:]CDPower:QINVert ON   OFF                                                                                                                                                                                                                                          |
| SIDE BAND<br>NORM INV  | : [SENSe:]CDPower:SBAND NORMal   INVerse                                                                                                                                                                                                                                    |
| NORMALIZE<br>ON OFF    | : [SENSe:]CDPower:NORMalize ON   OFF                                                                                                                                                                                                                                        |
| RESULTS                | --                                                                                                                                                                                                                                                                          |
| CODE DOM<br>POWER      | <p>:CALCulate&lt;1&gt;:FEED `XPOW:CDP`<br/>:CALCulate&lt;1&gt;:FEED `XPOW:CDP:ABS`<br/>:CALCulate&lt;1&gt;:FEED `XPOW:CDP:RAT`</p>                                                                                                                                          |
| COMPOSITE<br>EVM       | :CALCulate2:FEED "XTIM:CDP:MACCuracy"                                                                                                                                                                                                                                       |

|                         |                                                                                                                                                                                                                                                                                                                                                                                                                                                                                                                                                                                                                         |
|-------------------------|-------------------------------------------------------------------------------------------------------------------------------------------------------------------------------------------------------------------------------------------------------------------------------------------------------------------------------------------------------------------------------------------------------------------------------------------------------------------------------------------------------------------------------------------------------------------------------------------------------------------------|
| PEAK CODE<br>DOMAIN ERR | :CALCulate2:FEED "XTIM:CDP:ERR:PCDomain"                                                                                                                                                                                                                                                                                                                                                                                                                                                                                                                                                                                |
| POWER<br>VS SLOT        | :CALCulate2:FEED "XTIM:CDP:PVSLOT"                                                                                                                                                                                                                                                                                                                                                                                                                                                                                                                                                                                      |
| RESULT<br>SUMMARY       | :CALCulate2:FEED "XTIM:CDP:ERR:SUMmary"<br><br>Query of results:<br>:CALCulate:MARKer:FUNction:WCDPower[:BTS]:RESult?<br>PTOTal   FERRor   TFRame   TOFFset   MACCuracy   PCDError   EVMRms  <br>EVMPeak   CERRor   CSLot   SRATE   CHANnel   CDPabsolute   CDPRelative<br>  IQOFFset   IQIMbalance   MTYPE                                                                                                                                                                                                                                                                                                             |
| COMPOSITE<br>CONST      | :CALCulate<1>:FEED "XTIM:CDP:COMP:CONStellation"<br><br>Query of results: TRACe<1>:DATA? TRACe2<br>Format: Re <sub>1</sub> ,Im <sub>1</sub>   Re <sub>2</sub> ,Im <sub>2</sub>   Re <sub>2560</sub> ,Im <sub>2560</sub><br>Unit: [1]<br>Quantity: 2560<br>:[SENSe:]CDPower:CODE 0...511                                                                                                                                                                                                                                                                                                                                 |
| SELECT<br>CHANNEL       |                                                                                                                                                                                                                                                                                                                                                                                                                                                                                                                                                                                                                         |
| SELECT<br>CPICH SLOT    | :[SENSe:]CDPower:SLOT 0 ... 14                                                                                                                                                                                                                                                                                                                                                                                                                                                                                                                                                                                          |
| ADJUST<br>REF LVL       | SENS:POW:ACH:PRES:RLEV                                                                                                                                                                                                                                                                                                                                                                                                                                                                                                                                                                                                  |
| CODE DOM<br>ERROR       | :CALCulate<1>:FEED "XPOWer:CDEP"<br><br>Query of result: :TRACe<1>:DATA? TRACe1<br>Output: CDEP list of each CC9 channel<br>Format: <code class> <sub>1</sub> , <code number> <sub>1</sub> , <CDEP> <sub>1</sub> , <channel flag> <sub>1</sub> , <code class> <sub>2</sub> ,<br><code number> <sub>2</sub> , <CDEP> <sub>2</sub> , <channel flag> <sub>2</sub> ,<br>.....<br><code class> <sub>512</sub> , <code number> <sub>512</sub> , <CDEP> <sub>512</sub> , <channel flag> <sub>512</sub><br>Unit: < [1] >, < [1] >, < [dB] >, < [1] ><br>Range: < 9 >, < 0...511 >, < -∞ ... ∞ >, < 0 ; 1 ; 3 ><br>Quantity: 512 |
| CHANNEL<br>TABLE        | :CALCulate<1>:FEED "XTIM:CDP:ERR:CTable"                                                                                                                                                                                                                                                                                                                                                                                                                                                                                                                                                                                |
| POWER<br>VS SYMBOL      | :CALCulate<1>:FEED "XTIM:CDP:PVSymbol"<br><br>Query of results: TRACe<1>:DATA? TRACe2<br>Format: Val <sub>1</sub>   Val <sub>2</sub>     Val <sub>NOF</sub><br>Unit: [dB]<br>Quantity: $NOF_{Symbols} = 10 \cdot 2^{(8-CodeClass)}$                                                                                                                                                                                                                                                                                                                                                                                     |
| SYMBOL<br>CONST         | :CALCulate2:FEED "XTIM:CDP:SYMB:CONStellation"                                                                                                                                                                                                                                                                                                                                                                                                                                                                                                                                                                          |
| SYMBOL<br>EVM           | :CALCulate2:FEED "XTIM:CDP:SYMB:EVM"                                                                                                                                                                                                                                                                                                                                                                                                                                                                                                                                                                                    |
| BITSTREAM               | :CALCulate2:FEED "XTIM:CDP:BSTReam"                                                                                                                                                                                                                                                                                                                                                                                                                                                                                                                                                                                     |

## 8 Performance Test

- Switch off the FSU before removing or inserting modules.
- Check the setting of the AC supply voltage selector (230 V) prior to switching on the unit.
- Measure the parameters after a warm-up time of at least 30 min. and the completion of system error correction of the FSU and SMIQ. Only then is compliance with specifications ensured.
- Unless specified otherwise, all settings are made after a PRESET.
- Conventions for settings on the FSU during the measurement:

[<Key>]            Press a key on the front panel, e.g. [SPAN].  
 [<SOFTKEY>]      Press a softkey, e.g. [MARKER -> PEAK].  
 [<nn unit>]        Enter a value and terminate by entering the unit, e.g. [12 kHz].  
 {<nn>}             Enter values indicated in one of the following tables.

- Successive entries are separated by [:], e.g. [SPAN: 15 kHz].
- The values stated below in this document are not guaranteed values. Only the data sheet specifications are binding.

### Required Measuring Equipment and Accessories

Table 8-1        Required measuring equipment and accessories

| Item | Instrument type  | Recommended characteristics                            | Recommended equipment                                  | R&S Order No.                                                | Use |
|------|------------------|--------------------------------------------------------|--------------------------------------------------------|--------------------------------------------------------------|-----|
| 1    | Signal generator | Vector signal generator for generating cdmaOne signals | SMIQ<br>with options:<br>SMIQB42<br>SMIQB20<br>SMIQB11 | 1125.5555.xx<br>1104.7936.02<br>1125.5190.02<br>1085.4502.04 |     |

### Test Procedure

The performance test refers exclusively to results of the code domain power. It is not necessary to check the POWER-, ACLR- and SPECTRUM results since they are covered by the performance test of the base unit.

Default settings on the SMIQ:

```

[PRESET]
[LEVEL :            0 dBm]
[FREQ:             2.1175 GHz]
DIGITAL STD
WCDMA 3GPP
TEST MODELS ...
TEST1_32
SELECT BS/MS
BS 1 ON
STATE: ON

```

Trigger output: *RADIO FRAME*

Check set channels against the following table:

| CHNO | TYPE    | SYM.R | CH.CD | POW   | DATA | TOFFS | PILOT | TPC     | MC  | STATE |
|------|---------|-------|-------|-------|------|-------|-------|---------|-----|-------|
| 0    | P-CPICH | 15    | 0     | -10.0 |      |       |       |         | OFF | ON    |
| 2    | P-SCH   | 15    |       | -13.0 |      |       |       |         | OFF | ON    |
| 3    | S-SCH   | 15    |       | -13.0 |      |       |       |         | OFF | ON    |
| 4    | P-CCPCH | 15    | 1     | -10.0 | PN9  |       |       |         |     | ON    |
| 6    | PICH    | 15    | 16    | -15.0 | PATT | 120   |       |         |     | ON    |
| 11   | DPCH    | 30    | 2     | -13.0 | PN9  | 86    | 8     | PATTOFF |     | ON    |
| 12   | DPCH    | 30    | 11    | -13.0 | PN9  | 134   | 8     | PATTOFF |     | ON    |
| 13   | DPCH    | 30    | 17    | -14.0 | PN9  | 52    | 8     | PATTOFF |     | ON    |
| 14   | DPCH    | 30    | 23    | -15.0 | PN9  | 45    | 8     | PATTOFF |     | ON    |
| 15   | DPCH    | 30    | 31    | -17.0 | PN9  | 143   | 8     | PATTOFF |     | ON    |
| 16   | DPCH    | 30    | 38    | -14.0 | PN9  | 112   | 8     | PATTOFF |     | ON    |
| 17   | DPCH    | 30    | 47    | -16.0 | PN9  | 59    | 8     | PATTOFF |     | ON    |
| 18   | DPCH    | 30    | 55    | -18.0 | PN9  | 23    | 8     | PATTOFF |     | ON    |
| 19   | DPCH    | 30    | 62    | -16.0 | PN9  | 1     | 8     | PATTOFF |     | ON    |
| 20   | DPCH    | 30    | 69    | -19.0 | PN9  | 88    | 8     | PATTOFF |     | ON    |
| 21   | DPCH    | 30    | 78    | -17.0 | PN9  | 30    | 8     | PATTOFF |     | ON    |
| 22   | DPCH    | 30    | 85    | -15.0 | PN9  | 18    | 8     | PATTOFF |     | ON    |
| 23   | DPCH    | 30    | 94    | -17.0 | PN9  | 30    | 8     | PATTOFF |     | ON    |
| 24   | DPCH    | 30    | 102   | -22.0 | PN9  | 61    | 8     | PATTOFF |     | ON    |
| 25   | DPCH    | 30    | 113   | -20.0 | PN9  | 128   | 8     | PATTOFF |     | ON    |
| 26   | DPCH    | 30    | 119   | -24.0 | PN9  | 143   | 8     | PATTOFF |     | ON    |
| 27   | DPCH    | 30    | 7     | -20.0 | PN9  | 83    | 8     | PATTOFF |     | ON    |
| 28   | DPCH    | 30    | 13    | -18.0 | PN9  | 25    | 8     | PATTOFF |     | ON    |
| 29   | DPCH    | 30    | 20    | -14.0 | PN9  | 103   | 8     | PATTOFF |     | ON    |
| 30   | DPCH    | 30    | 27    | -14.0 | PN9  | 97    | 8     | PATTOFF |     | ON    |
| 31   | DPCH    | 30    | 35    | -15.0 | PN9  | 56    | 8     | PATTOFF |     | ON    |
| 32   | DPCH    | 30    | 41    | -19.0 | PN9  | 104   | 8     | PATTOFF |     | ON    |
| 33   | DPCH    | 30    | 51    | -18.0 | PN9  | 51    | 8     | PATTOFF |     | ON    |
| 34   | DPCH    | 30    | 58    | -17.0 | PN9  | 26    | 8     | PATTOFF |     | ON    |
| 35   | DPCH    | 30    | 64    | -22.0 | PN9  | 137   | 8     | PATTOFF |     | ON    |
| 36   | DPCH    | 30    | 74    | -19.0 | PN9  | 65    | 8     | PATTOFF |     | ON    |
| 37   | DPCH    | 30    | 82    | -19.0 | PN9  | 37    | 8     | PATTOFF |     | ON    |
| 38   | DPCH    | 30    | 88    | -16.0 | PN9  | 125   | 8     | PATTOFF |     | ON    |
| 39   | DPCH    | 30    | 97    | -18.0 | PN9  | 149   | 8     | PATTOFF |     | ON    |
| 40   | DPCH    | 30    | 108   | -15.0 | PN9  | 123   | 8     | PATTOFF |     | ON    |
| 41   | DPCH    | 30    | 117   | -17.0 | PN9  | 83    | 8     | PATTOFF |     | ON    |
| 42   | DPCH    | 30    | 125   | -12.0 | PN9  | 5     | 8     | PATTOFF |     | ON    |

all other channels      STATE      OFF

Default settings on the FSU:

**[PRESET]**  
**[CENTER:**                      2.1175 GHz]  
**[REF:**                              10 dBm]  
**[3G FDD BS]**  
**[TRIG**                              **EXTERN]**  
**[SETTINGS**                      **SCRAMBLING CODE 0]**  
**[DISPLAY**                      **CHANNEL TABLE]**

- Test setup and other settings:
- Connect external trigger input of the FSU to the SMIQ
  - Connect external reference output of the FSU to the SMIQ

UTILITIES

REF OSC

SMIQ

SOURCE: EXT

[SETUP:

REFERENCE INT]

FSU

The display of the FSU should show the following:



Channel Table

SR 30 ksps  
Chan Code 69  
Chan Slot 7

CF 2.1175 GHz CPICH Slot 0

| Channel Table |        |           |       |        |      |        |         |         |        |
|---------------|--------|-----------|-------|--------|------|--------|---------|---------|--------|
|               | Type   | Symb Rate | Chan# | Status | TFCI | PilotL | Pwr Abs | Pwr Rel | T Offs |
| Ref           | CPICH  | 15.0 ksps | 0     | active | ---  | ---    | -10.19  | -0.00   | ---    |
| 10.0          | PSCH   | -. ksps   | ---   | active | ---  | ---    | -16.29  | -6.10   | ---    |
| dBm           | SSCH   | -. ksps   | ---   | active | ---  | ---    | -15.85  | -5.67   | ---    |
| Att           | PCCPCH | 15.0 ksps | 1     | active | ---  | ---    | -10.18  | 0.01    | ---    |
| 35 dB         | -----  | -. ksps   | ---   | inactv | ---  | ---    | ---     | ---     | ---    |
|               | PICH   | 15.0 ksps | 16    | active | ---  | ---    | -18.20  | -8.02   | 30720  |
|               | DPCH   | 30.0 ksps | 69    | active | ON   | 8      | -19.16  | -8.97   | 22528  |
| 1             | DPCH   | 30.0 ksps | 74    | active | ON   | 8      | -19.20  | -9.01   | 16640  |
| CLRWR         | DPCH   | 30.0 ksps | 78    | active | ON   | 8      | -17.19  | -7.00   | 7680   |
|               | DPCH   | 30.0 ksps | 82    | active | ON   | 8      | -19.19  | -9.00   | 9472   |

A

TRG

PRN

Result Summary

SR 30 ksps  
Chan Code 69  
Chan Slot 7

CF 2.1175 GHz CPICH Slot 0

| Result Summary  |                   |            |                                  |
|-----------------|-------------------|------------|----------------------------------|
| GLOBAL RESULTS  |                   |            |                                  |
| Ref             | Total Power       | -0.26 dBm  | Carrier Freq Error -83.91 mHz    |
| 10.0            | Chip Rate Error   | 0.01 ppm   | Trigger to Frame 0.00 s          |
| dBm             | IQ Offset         | 0.19 %     | IQ Imbalance 0.06 %              |
| Att             | Composite EVM     | 1.41 % rms | Pk CDE (15.0 ksps) -57.83 dB rms |
| 35 dB           | CPICH Slot No     | 0          | No of Active Chan 35             |
| CHANNEL RESULTS |                   |            |                                  |
|                 | Symbol Rate       | 30.00 ksps | Timing Offset 22528 Chips        |
| 1               | Channel Code      | 69         | Channel Slot No 7                |
| CLRWR           | No of Pilot Symb  | 8          |                                  |
|                 | Channel Power Rel | -8.97 dB   | Channel Power Abs -19.16 dBm     |
|                 | Symbol EVM        | 1.10 % rms | Symbol EVM 1.78 % Pk             |

B

EXT

Date: 14.DEC.2001 13:39:42

## 9 Glossary

|                            |                                                                                                                                                                                                                                                                                                                                                   |
|----------------------------|---------------------------------------------------------------------------------------------------------------------------------------------------------------------------------------------------------------------------------------------------------------------------------------------------------------------------------------------------|
| CPICH                      | <p>Common pilot channel (spreading code number 0 at spreading factor 128).</p> <p>The channel constantly contains the symbol (1,1) throughout the total length of the 3GPP FDD frame. For the measurements, the CPICH (Primary CPICH) is used for synchronization. For this reason, the CPICH must be contained in the signal to be measured.</p> |
| Composite EVM              | <p>In accordance with the 3GPP specifications, the squared error between the real and imaginary components of the test signal and an ideal reference signal is determined (EVM referenced to the total signal) in a composite EVM measurement.</p>                                                                                                |
| DPCH                       | <p>Dedicated physical channel, data channel. The data channels, which can be sent at different transmission rates, are automatically recognized during the measurement.</p>                                                                                                                                                                       |
| Inactive channel threshold | <p>Minimum power that a single channel must have as compared to the total signal in order to be recognized as an active channel.</p>                                                                                                                                                                                                              |
| PCCPCH                     | <p>Primary common control physical channel (spreading code number 1 at spreading factor 128).</p> <p>The channel is used for synchronizing the measurements. For this reason, it must be contained in the signal to be measured.</p>                                                                                                              |
| Peak code domain error     | <p>In accordance with the 3GPP specifications, the error between the test signal and the ideal reference signal is projected onto the classes of the different spreading factors in the case of a peak code domain measurement.</p>                                                                                                               |
| PICH                       | <p>Paging indication channel.</p> <p>This special channel is defined in the test models to 3GPP for measurements on base station signals. Since it does not contain any pilot symbols, it cannot automatically be recognized during measurement. Therefore, this channel must be deactivated for CDP measurements.</p>                            |
| SCH                        | <p>Synchronization channel, divided into P-SCH (primary synchronization channel) and S-SCH (secondary synchronization channel).</p> <p>The two channels are required for synchronizing the measurement. Therefore, they must always be contained in the signal to be measured.</p>                                                                |
| Timing offset              | <p>Offset between the start of the first slot of a channel and the start of the analyzed 3GPP FDD frame (in multiples of 256 chips).</p>                                                                                                                                                                                                          |

## 10 Index

- \*  
\* (enhancement label)..... 96
- A**  
ACLR..... 30  
ACP measurement ..... 30  
Adjacent-channel power ..... 30  
    number of channels..... 39  
Amplitude power distribution ..... 51  
Amplitude probability distribution function ..... 51, 52  
APD function..... 52  
Attenuation ..... 92  
Averaging ..... 96
- B**  
Bandwidth  
    Occupied..... 49  
Bit stream ..... 75
- C**  
Carrier freq error..... 66  
CCDF  
    Complementary cumulative distribution function ..... 51  
CCDF function ..... 52  
CDP rel. .... 80  
Center frequency ..... 91  
    Step size ..... 91  
Chan #..... 72, 80  
Chan pow rel. / abs..... 67  
Channel ..... 77  
    power ..... 42  
    bandwidth ..... 40  
    Bandwidth ..... 34, 35  
    number ..... 39  
    Number ..... 31  
    Power  
        Absolute/relative ..... 36  
        spacing ..... 41  
        Spacing ..... 35  
        Status ..... 80  
Channel assignment table ..... 70  
Channel code ..... 67  
Channel number ..... 80  
Channel power  
    Relative ..... 80  
Channel slot No ..... 67  
Channel, active ..... 84, 150  
Chip rate error ..... 66  
Clear/Write mode ..... 96  
Code domain power ..... 68  
Code domain power ..... 59  
Commands  
    Assignment to softkeys..... 139  
    Description ..... 99  
Common pilot channel ..... 94, 150  
Composite EVM..... 62, 66, 150  
Correction  
    inherent noise..... 37  
CPICH ..... 150  
CPICH slot..... 77  
CPICH slot No ..... 66  
Culmulative distribution function..... 52
- D**  
Default  
    Scales of x and y axis ..... 54  
Default setting  
    Preset ..... 11  
Display range  
    Frequency ..... 91  
Distribution function ..... 52  
Distribution function of signal amplitudes ..... 51  
DPCH..... 150
- F**  
Fast power measurement..... 38  
Fast power measurement..... 32  
Frequency  
    Center..... 91  
    Offset..... 91
- H**  
Hotkey  
    3G FDD BS..... 26  
    CHAN CONF ..... 26, 78  
    EXIT 3GPP ..... 26  
    RESULTS ..... 26, 57  
    SETTINGS..... 26, 83
- I**  
I/Q imbalance ..... 66  
I/Q offset ..... 66  
Inactive channel threshold..... 150  
Inherent noise, Correction ..... 37
- K**  
Key  
    AMPT ..... 92  
    BW ..... 95  
    DISP ..... 98  
    FREQ ..... 91  
    LINES ..... 98  
    MARKER ..... 93  
    MEAS ..... 28, 95  
    MKR→ ..... 94  
    SPAN ..... 91  
    SWEEP ..... 95  
    TRACE ..... 96  
    TRIG ..... 95
- L**  
Level  
    Reference ..... 92  
Limit  
    ACP measurement ..... 43  
    Probability range ..... 53  
Limit check  
    ACLR measurement ..... 33  
    ACP measurement ..... 43

**M**

|                          |    |
|--------------------------|----|
| Marker                   |    |
| Peak.....                | 94 |
| Zoom.....                | 93 |
| Max hold.....            | 96 |
| Maximum search.....      | 94 |
| Menu overview.....       | 26 |
| Min hold.....            | 96 |
| Modulation accuracy..... | 62 |
| Modulation type.....     | 67 |

**N**

|                           |    |
|---------------------------|----|
| No of active channel..... | 66 |
| No of pilot bits.....     | 67 |
| Noise, Correction.....    | 37 |
| Number                    |    |
| Pilot bits.....           | 67 |

**O**

|                      |    |
|----------------------|----|
| Offset               |    |
| Frequency.....       | 91 |
| Reference level..... | 92 |

**P**

|                                              |             |
|----------------------------------------------|-------------|
| PCCPCH.....                                  | 150         |
| Peak code domain error.....                  | 63, 66, 150 |
| Peak search.....                             | 94          |
| Performance test.....                        | 147         |
| PICH.....                                    | 150         |
| Pilot bits.....                              | 80          |
| PilotL.....                                  | 72          |
| Pk CDE.....                                  | 66          |
| Power                                        |             |
| Adjacent-channel power.....                  | 30          |
| Channel power.....                           | 29          |
| Ref. to 1 Hz bandwidth.....                  | 36          |
| Power bandwidth                              |             |
| Percentage.....                              | 50          |
| Power group.....                             | 64          |
| Power measurement.....                       | 29          |
| Fast.....                                    | 32, 38      |
| Power of 3GPP FDD signal.....                | 44          |
| Preset.....                                  | 11          |
| Primary common control physical channel..... | 94, 150     |
| Pwr Abs.....                                 | 72          |
| Pwr Rel.....                                 | 72          |

**R**

|                      |        |
|----------------------|--------|
| RECENT.....          | 78     |
| Reference level..... | 92     |
| channel power.....   | 38     |
| Channel power.....   | 50, 77 |
| Offset.....          | 92     |
| Remote control.....  | 99     |
| RF attenuation.....  | 92     |

**S**

|                                      |    |
|--------------------------------------|----|
| Sampler number.....                  | 52 |
| Scaling                              |    |
| x and y axis (signal statistic)..... | 53 |

|                                               |                            |
|-----------------------------------------------|----------------------------|
| SCCPCH.....                                   | 24                         |
| SCH.....                                      | 150                        |
| Scrambling code.....                          | 83                         |
| Search                                        |                            |
| Peak.....                                     | 94                         |
| Selection                                     |                            |
| Channel.....                                  | 77                         |
| Slot.....                                     | 77                         |
| Sensitivity                                   |                            |
| APD measurement.....                          | 54                         |
| CCDF measurement.....                         | 54                         |
| Signal amplitudes, distribution function..... | 51                         |
| Signal statistics.....                        | 51                         |
| Slot number                                   |                            |
| Channel.....                                  | 67                         |
| CPICH.....                                    | 66                         |
| Softkey                                       |                            |
| % POWER BANDWIDTH.....                        | 50                         |
| 3GPP BTS ANALYZER.....                        | 119                        |
| ACLR.....                                     | 28, 30, 113                |
| ACLR LIMIT CHECK.....                         | 33                         |
| ACP LIMIT CHECK.....                          | 43                         |
| ACP REF SETTINGS.....                         | 41                         |
| ADD SPECIAL.....                              | 81                         |
| ADJ CHAN BANDWIDTH.....                       | 35, 40                     |
| ADJ CHAN SPACING.....                         | 35, 41                     |
| ADJUST REF LVL.....                           | 29, 33, 38, 48, 50, 77, 92 |
| ADJUST SETTINGS.....                          | 50, 54                     |
| ADJUST SETTINGS (power measurements).....     | 42                         |
| ALL MARKER OFF.....                           | 93                         |
| ANT DIV ON/OFF.....                           | 87                         |
| ANT NO. 1/2.....                              | 88                         |
| APD ON/OFF.....                               | 52                         |
| AVERAGE.....                                  | 96                         |
| BITSTREAM.....                                | 75, 100, 132               |
| CAPTURE LENGTH.....                           | 89                         |
| CCDF.....                                     | 111, 113                   |
| CCDF ON/OFF.....                              | 52                         |
| CENTER.....                                   | 91                         |
| CHAN PWR / HZ.....                            | 36, 42                     |
| CHAN TABLE HEADER.....                        | 115                        |
| CHAN TABLE VALUES.....                        | 115                        |
| CHANNEL BANDWIDTH.....                        | 34                         |
| CHANNEL TABLE.....                            | 70, 100, 132               |
| CLEAR/WRITE.....                              | 96                         |
| CODE CHAN AUTOSEARCH.....                     | 78, 114                    |
| CODE CHAN PREDEFINED.....                     | 78, 114                    |
| CODE DOM ERROR.....                           | 100                        |
| CODEDOMERROR.....                             | 68                         |
| CODE DOM POWER.....                           | 100                        |
| CODE DOM POWER.....                           | 28, 59                     |
| CODE PWR ABSOLUTE.....                        | 132                        |
| CODE PWR RELATIVE.....                        | 132                        |
| COMP MODE ON/OFF.....                         | 86                         |
| COMPOSITE EVM.....                            | 62, 100, 113, 132          |
| COMPRESSED MODE.....                          | 122                        |
| CONT MEAS.....                                | 54                         |
| COPY CHAN CONF TABLE.....                     | 82, 115                    |
| CP/ACP ABS/REL.....                           | 36, 42                     |
| CP/ACP CONFIG.....                            | 39                         |
| DEFAULT SETTINGS.....                         | 54                         |
| DEL CHAN CONF TABLE.....                      | 82, 116                    |
| DELETE LINE.....                              | 81                         |
| DIAGRAM FULL SIZE.....                        | 33                         |
| EDIT ACLR LIMIT.....                          | 34                         |
| EDIT ACP LIMITS.....                          | 43, 104                    |
| EDIT CHAN CONF TABLE.....                     | 79, 114                    |
| ESG OPT 101.....                              | 46, 47, 48, 89, 90         |
| FAST ACLR ON/OFF.....                         | 32                         |
| FAST ACP ON/OFF.....                          | 38                         |
| FRAME TO ANALYZE.....                         | 89                         |
| FREQUENCY OFFSET.....                         | 91                         |
| FULL SIZE DIAGRAM.....                        | 38                         |



|                                     |              |
|-------------------------------------|--------------|
| HEADER/VALUES .....                 | 80           |
| INACT CHAN THRESH .....             | 84, 123      |
| INSERT LINE .....                   | 81           |
| INSTALL OPTION .....                | 9            |
| INVERT Q .....                      | 90, 122      |
| LIMIT LINE AUTO .....               | 45, 106      |
| LIMIT LINE MANUAL .....             | 45, 106      |
| LIMIT LINE USER .....               | 45, 106      |
| MARKER -> CPICH .....               | 94, 107      |
| MARKER -> PCCPCH .....              | 94, 107      |
| MARKER 1 to 4 .....                 | 93           |
| MARKER NORM/DELTA .....             | 93           |
| MARKER ZOOM .....                   | 93           |
| MAX HOLD .....                      | 96           |
| MEAS CHAN CONF TABLE .....          | 81           |
| MIN HOLD .....                      | 96           |
| MULT CARR ACP .....                 | 37           |
| MULTI FRAME CAPTURE .....           | 88           |
| NEW CHAN CONF TABLE .....           | 82, 114      |
| NEXT MODE LEFT/RIGHT .....          | 94           |
| NEXT PEAK .....                     | 94           |
| NO OF SAMPLES .....                 | 52, 111      |
| NO. OF ADJ CHAN .....               | 31, 39       |
| NO. OF TX CHAN .....                | 39           |
| NOISE CORR ON/OFF .....             | 32, 37       |
| NORMALIZE ON / OFF .....            | 90, 121      |
| OCCUPIED BANDWIDTH .....            | 28, 49, 113  |
| OPTIONS .....                       | 9            |
| PEAK .....                          | 94           |
| PEAK CODE DOMAIN ERR .....          | 63, 100, 132 |
| PEAK MODE MIN/MAX .....             | 94           |
| PERCENT MARKER .....                | 52           |
| POW DIFF ON/OFF .....               | 88           |
| POWER .....                         | 28, 29, 113  |
| POWER REF TOT / CPICH .....         | 85, 123      |
| POWER VS SLOT .....                 | 64, 100, 132 |
| REF LEVEL .....                     | 92           |
| REF LEVEL OFFSET .....              | 92           |
| REF VALUE POSITION .....            | 92           |
| RESTORE STD LINES .....             | 46           |
| RESULT DISPLAY .....                | 100, 132     |
| RESULT SUMMARY .....                | 66, 100, 132 |
| RF ATTEN AUTO .....                 | 92           |
| RF ATTEN MANUAL .....               | 92           |
| SAVE TABLE .....                    | 81           |
| SCALING .....                       | 53           |
| SCRAMBLING CODE .....               | 83, 122      |
| SCREEN .....                        | 97           |
| SELECT CHANNEL .....                | 77, 121      |
| SELECT CPICH SLOT .....             | 77, 122      |
| SELECT MARKER .....                 | 94           |
| SELECT PCDE SF .....                | 121          |
| SIDE BAND NORM / INV .....          | 90, 122      |
| SINGLE MEAS .....                   | 54           |
| SORT TABLE .....                    | 82           |
| SPECTRUM .....                      | 113          |
| SPECTRUM EM MASK .....              | 28, 44, 113  |
| STATISTICS .....                    | 28, 51       |
| SWEEP COUNT .....                   | 96           |
| SWEEP TIME .....                    | 32           |
| SYMBOL CONST .....                  | 74, 100, 132 |
| SYMBOL EVM .....                    | 75, 100, 132 |
| SYNC TYPE CPICH/SCH .....           | 87           |
| TIME DOMAIN .....                   | 113          |
| VIEW .....                          | 96           |
| X-AXIS RANGE .....                  | 53           |
| X-AXIS REF LEVEL .....              | 53           |
| Y MAX .....                         | 112          |
| Y MIN .....                         | 112          |
| Y PER DIV .....                     | 92           |
| Y-AXIS MAX VALUE .....              | 53           |
| Y-AXIS MIN VALUE .....              | 53           |
| Specifications .....                | 147          |
| Spectrum emission mask .....        | 44           |
| Spreading code .....                | 67           |
| Spreading factor .....              | 121          |
| Status .....                        | 72, 80       |
| Stepsize .....                      |              |
| Center frequency .....              | 91           |
| Symbol constellation .....          | 74           |
| Symbol error vector magnitude ..... | 75           |
| Symbol EVM Pk / rms .....           | 67           |
| Symbol rate .....                   | 67, 72, 80   |
| <b>T</b>                            |              |
| T Offs .....                        | 72           |
| Taste .....                         |              |
| FILE .....                          | 98           |
| MKR FCTN .....                      | 95           |
| Test models .....                   | 24           |
| Test setup .....                    | 22           |
| TFCI .....                          | 72           |
| TFCI symbols .....                  | 80           |
| Timing offset .....                 | 67, 80, 150  |
| Total power .....                   | 36, 66       |
| Trace .....                         |              |
| Average .....                       | 96           |
| Clear/Write .....                   | 96           |
| Freeze .....                        | 96           |
| Max hold .....                      | 96           |
| Min hold .....                      | 96           |
| Trigger to frame .....              | 66           |
| <b>U</b>                            |              |
| Use TFCI .....                      | 80           |
| <b>V</b>                            |              |
| View trace .....                    | 96           |
| <b>Z</b>                            |              |
| Zoom .....                          | 93           |
| Amplitude .....                     | 96           |